

PRINTER PRESENTER UNIT
Command Reference

Model: PPU-700

Revision: 1.03 2006/10/26

CITIZEN SYSTEMS JAPAN CO.,LTD.

REVISION

Rev No.	Date	Comment
0.00	2004/01/14	Newly issued
1.00	2005/03/4	"GS g 0", "GS g 2", "FS g 3", "FS g 4", "GS (K (fn = 200 ~ 208)", "GS (E (fn = 5:200 ~ 211, 240/fn = 6: 200 ~ 211)", "GS I (n = 250, 251)"were deleted
1.02	2005/04/25	Change of code pages
1.03	2006/10/26	Add 4.5 Black Mark Layout and Operating Condition

TABLE OF CONTENTS

1. OUTLINE	6
1.1 Operation Mode	6
1.2 Character Set	6
1.3 Control Commands	6
1.3.1 Control Command Details	6
1.3.2 How to Send Control Commands	6
2. CONTROL COMMANDS	7
2.1 ESC/POS Command List	7
2.1.1 Description of Items	11
2.2 Command Details	12
2.2.1 Print Control Commands	12
LF	12
CR	12
FF	13
ESC FF	14
ESC J n	15
ESC d n	16
2.2.2 Print Character Commands	17
CAN	17
ESC SP n	18
ESC ! n	19
ESC % n	21
ESC & s n m [a [p] s×a] m-n+1	22
ESC – n	23
ESC ? n	24
ESC E n	25
ESC G n	26
ESC M n	27
ESC R n	27
ESC V n	28
ESC t n	29
ESC { n	30
GS ! n	31
GS B n	32
GS b n	33
2.2.3 Print Position Commands	34
HT	34
ESC \$ n1 n2	35
ESC D [n]k NULL	36
ESC T n	37
ESC W xL xH yL yH dxL dxH dyL dyH	38
ESC \ nL nH	40
ESC a n	41

GS \$ nL nH.....	42
GS L nL nH.....	43
GS T n.....	44
GS W nL nH.....	45
GS \ nL nH.....	47
2.2.4 Line Feed Span Commands.....	48
ESC 2.....	48
ESC 3 n.....	49
2.2.5 Bit Image Commands.....	50
ESC * m n1 n2 [d]k.....	50
GS * n1 n2 [d] n1×n2×8.....	52
GS / m.....	53
GS v 0 m xL xH yL yH d1...dk.....	54
2.2.6 Status Commands.....	56
DLE EOT n.....	56
ESC v (At Serial I/F Selection).....	59
GS a n.....	60
GS r n.....	63
2.2.7 Paper Detecting Commands.....	64
ESC c 3 n.....	64
ESC c 4 n.....	65
2.2.8 Panel Switch Commands.....	66
ESC c 5 n.....	66
2.2.9 Macro Commands.....	67
GS :.....	67
GS ^ n1 n2 n3.....	68
2.2.10 Cutter Commands.....	69
ESC i.....	69
ESC m.....	70
GS V m ... (1).....	71
GS V m n ... (2).....	71
2.2.11 Bar Code Commands.....	72
GS H n.....	72
GS f n.....	73
GS h n.....	74
GS k m [d1...dk] NULL ... (1).....	75
GS k m n [d1...dn] ... (2).....	75
GS w n.....	81

2.2.12 Commands for Non-volatile Memory	82
GS (C pL pH m fn b [c1 c2] [d1...dk]	82
fn = 0, 48: Function 0 Erasing Specified Record	83
fn = 1, 49: Function 1 Storing Data to Specified Record	83
fn = 2, 50: Function 2 Sending Data Stored in Specified Record	84
fn = 3, 51: Function 3 Sending Use Amount	85
fn = 4, 52: Function 4 Sending Remaining Capacity	85
fn = 5, 53: Function 5 Sending Key Code List of Stored Record	86
fn = 6, 54: Function 6 Erasing All User NV Memory Area in a Lump	87
FS p n m	88
FS q n [xL xH yL yH d1...dk]1 ... [xL xH yL yH d1...dk]n	89
2.2.13 Printer Function Setting Commands	92
GS (E pL pH fn [...]	92
fn = 1: Function 1 Transferring to Printer Function Setting Mode.....	93
fn = 2: Function 2 End of Printer Function Setting Mode.....	93
fn = 3: Function 3 Setting Memory Switch Value.....	94
fn = 4: Function 4 Sending the Set Memory Switch Value	96
fn = 5: Function 5 Setting Customized Value	97
fn = 6: Function 6 Sending the Set Customized Value	100
fn = 7: Function 7 Copying User-defined Page	103
fn = 8: Function 8 Defining Data by the Column Format to Character Code Page of Work Area..	104
fn = 9: Function 9 Defining Data in the Raster Format to the Character Code Page of Work Area	105
fn = 10: Function 10 Erasing Data of Character Code Page Data in Work Area	106
fn = 11: Function 11 Setting Communication Conditions of Serial Interface	107
fn = 12: Function 12 Sending the Set Communication Conditions of Serial Interface	108
fn = 48: Function 48 Erasing Paper Layout.....	109
fn = 49: Function 49 Setting Paper Layout	110
fn = 50: Function 50 Sending Paper Layout Information	111
fn = 255: Function 255 Setting All Contents Set by Printer Function Setting Mode to the State at Shipment.....	112
GS (K pL pH fn m	113
fn = 48: Function 48 Setting Print Control Mode	113
fn = 49: Function 49 Setting Printing Density	114
fn = 50: Function 50 Setting Printing Speed	115
fn = 97: Function 97 Setting Number of Divisions for Head Conducting	115
GS (M pL pH fn m	116
fn = 1, 49: Function 1 Copies the set value stored in work area to the storage area.....	117
fn = 2, 50: Function 2 Copies the set value stored in storage area to the work area.....	117
fn = 3, 51: Function 3 Specifies the auto loading function of the set value at initialization to be valid or invalid	118
GS (N pL pH fn m	119
fn = 48: Function 48 Selects character color	119

2.2.14 Special Commands	120
ESC n n	120
ESC Y n1 n2	120
GS R 0	121
GS R 1 n	121
GS S	122
FS (L pL pH fn m	123
fn = 48: Function 48 Sending Position Information.....	124
fn = 66: Function 66 Executing Paper Feeding to Cut Position.....	125
fn = 67: Function 67 Executing Paper Feeding to Initial Position.....	125
2.2.15 Other Commands	126
DLE ENQ n	126
DLE DC4 fn m t (Specification of fn = 8)	127
ESC = n	128
ESC @	129
ESC L	130
ESC S	131
ESC RS	131
GS (A pL pH n m	132
GS I n	133
GS P x y	135
GS (L pL pH m fn [parameter]	136
GS 8 L p1 p2 p3 p4 m fn [parameter]	136
fn = 0, 48: Function 48 Sending NV Graphics Memory Capacity.....	137
fn = 2, 50: Function 50 Printing Graphics Data Stored in Print Buffer.....	137
fn = 3, 51: Function 51 Sending the Remaining Amount of NV Graphics Memory.....	138
fn = 64: Function 64 Sending Key Code List of Defined NV Graphics.....	139
fn = 65: Function 65 Erasing All Data of NV Graphics in a Lump.....	140
fn = 66: Function 66 Erasing Specified NV Graphics Data.....	140
fn = 67: Function 67 Defining Raster Type Graphics Data to NV Memory.....	141
fn = 69: Function 69 Printing Specified Graphics.....	142
fn = 112: Function 112 Storing Raster Type Graphics Data to Print Buffer.....	143
GS C 0 n m	144
GS C 1 aL aH bL bH n r	145
GS C 2 nL nH	145
GS C ; sa ; sb ; sn ; sr ; sc ;	146
GS c	146

3. CHARACTER CODE TABLE	147
3.1 Code Page	147
3.1.1 Code page 00H to 7FH & PC437 (USA, Europe Standard).....	147
3.1.2 Code page 00H to 7FH & Katakana	148
3.1.3 Code page 00H to 7FH & PC850 (Multilingual)	149
3.1.4 Code page 00H to 7FH & PC860 (Portuguese).....	150
3.1.5 Code page 00H to 7FH & PC863 (Canadian-French)	151
3.1.6 Code page 00H to 7FH & PC865 (Nordic)	152
3.1.7 Code page 00H to 7FH & PC852 (Eastern Europe).....	153
3.1.8 Code page 00H to 7FH & PC866 (Russian)	154
3.1.9 Code page 00H to 7FH & PC857(Turkish)	155
3.1.10 Code page 00H to 7FH & PC864 (Arabic)	156
3.1.11 Code page 00H to 7FH & Windows Code page.....	157
3.2 International Character Code Table	158
4. APPENDIX.....	159
4.1 Explanation on PAGE MODE	159
4.1.1 Overview	159
4.1.2 Values Set by Each Command in STANDARD MODE and PAGE MODE.....	159
4.1.3 Mapping of Print Data in the Print Area	160
4.1.4 Example of Using PAGE MODE	162
4.2 Bidirectional Parallel Interface	165
4.2.1 Parallel Interface Communication Mode.....	165
4.2.2 Interfacing Phases	166
4.2.3 Negotiation	167
4.3 Identification of Send Status	174
4.4 Memory Switch.....	175
4.4.1 Memory Switches.....	175
4.4.2 Details of Memory Switches.....	176
4.5 Black Mark Layout and Operating Condition.....	186

1. OUTLINE

1.1 Operation Mode

PPU-700 has ESC/POS™ as control commands.

1.2 Character Set

All print data sent from the host computer to the printer are automatically converted to one-byte alphanumeric or katakana characters (ANK) or two-byte Kanji corresponding to the characters and symbols.

NOTE: For the contents of character set, refer to "3. Character Code Table" of this document.

1.3 Control Commands

1.3.1 Control Command Details

Control Commands are used for controlling the operations of the printer such as starting/stopping of printing, line feeding, paper feeding, etc. They control all functions related to printing, such as type of characters, enlargement of characters or setting of format.

1.3.2 How to Send Control Commands

Some methods are available for sending Control Commands from the host computer to the printer. Here, a method of sending by BASIC programming is explained.

Example 1

Let's print a character string "CITIZEN" in enlarged (double-height, double-width) and in normal format.

Program coding

The Control Command shows that the command name for setting the size of a character is GS !. Let's make a program using this code. An example is shown below.

Program List

```
10 A$="CITIZEN"  
20 LPRINT CHR$(&H1D);"!"; CHR$(&H33);  
30 LPRINT A$;  
40 LPRINT CHR$(&HA); CHR$(&HA);  
50 LPRINT CHR$(&H1D);"!"; CHR$(&H00);  
60 LPRINT A$;  
70 END
```

Print Result

CITIZEN

CITIZEN

In lines 20 and 50, setting and canceling of enlarging a character is sent. As a result, lines 30 and 60 print the same character string but line 30 prints enlarged characters and line 60 cancels the enlargement and prints in normal format.

* In this document, sample programs are in BASIC. For details of BASIC programming, refer to the manual for BASIC.

2. CONTROL COMMANDS

2.1 ESC/POS Command List

OPrint Control Commands

Command	Function	MODE	GS P	Page
LF	Printing and paper feed	S·P		12
CR	Back to printing	S·P		12
FF	(1) Printing in PAGE MODE and returning to STANDARD MODE (at the selection of PAGE MODE) (2) Printing of Black mark and paper feeding to the top of the print position (with Black mark paper selected)	P		13
ESC_FF	Printing data in PAGE MODE	P		14
ESC_J	Printing and feeding paper in minimum pitch	S·P	○	15
ESC_d	Printing and feeding the paper by "n" lines	S·P		16

OPrint Character Commands

Command	Function	MODE	GS P	Page
CAN	Canceling print data in PAGE MODE	P		17
ESC_SP	Setting the right spacing of the character	S·P	○	18
ESC_!	Collectively specifying the printing mode	S·P		19
ESC_%	Specifying/canceling download character set	S·P		21
ESC_&	Defining the download characters	S·P		22
ESC_—	Specifying/canceling underline	S·P		23
ESC_?	Deleting download characters	S·P		24
ESC_E	Specifying/canceling emphasis printing	S·P		25
ESC_G	Specifying/canceling double strike printing	S·P		26
ESC_M	Selection of character fonts	S·P		27
ESC_R	Selecting the international character set	S·P		27
ESC_V	Specifying/canceling 90°-right-turned characters	S		28
ESC_t	Selecting the character code table	S·P		29
ESC_{	Specifying/canceling the inverted characters	S		30
GS_!	Specifying the character size	S·P		31
GS_B	Specifying/canceling the black/white inverted printing	S·P		32
GS_b	Specifying/canceling the smoothing	S·P		33

OPrint Position Commands

Command	Function	MODE	GS P	Page
HT	Horizontal tab	S·P		34
ESC \$	Specifying the absolute positions	S·P	○	35
ESC D	Setting horizontal tab position	S·P		36
ESC T	Selecting the character printing direction in PAGE MODE	P		37
ESC W	Defining the print area in PAGE MODE	P	○	38
ESC \	Specifying the relative position	S·P	○	40
ESC a	Aligning the characters	S		41
GS \$	Specifying the absolute vertical position of characters in PAGE MODE	P	○	42
GS L	Setting the left margin	S	○	43
GS T	Moving print position to top of the line	S		44
GS W	Setting the print area width	S·P	○	45
GS \	Specifying the relative vertical position of a character in PAGE MODE	S·P	○	47

OLine Feed Span Commands

Command	Function	MODE	GS P	Page
ESC 2	Specifying 1/6-inch line feed rate	S·P		48
ESC 3	Setting line feed rate of minimum pitch	S·P	○	49

OBit Image Commands

Command	Function	MODE	GS P	Page
ESC *	Specifying the bit image mode	S·P		50
GS *	Defining the download bit image	S·P		52
GS /	Printing the downloaded bit image	S·P		53
GS v 0	Printing of raster bit image	S		54

OStatus Commands

Command	Function	MODE	GS P	Page
DLE EOT	Sending status in real-time	S·P		56
ESC v	Sending printer status	S·P		59
GS a	Enabling/disabling ASB (Automatic Status Back)	S·P		60
GS r	Sending status	S·P		63

OPaper Detecting Commands

Command	Function	MODE	GS P	Page
ESC c 3	Selecting the Paper Sensor valid for Paper-end signal output	S·P		64
ESC c 4	Selecting the Paper Near-end Sensor valid for print stop	S·P		65

OPanel Switch Commands

Command	Function	MODE	GS P	Page
ESC c 5	Enabling/disabling the panel switches	S·P		66

OMacro Commands

Command	Function	MODE	GS P	Page
GS :	Starting/ending macro definition	S·P		67
GS ^	Executing the macro	S·P		68

OCutter Commands

Command	Function	MODE	GS P	Page
ESC_i	Full cutting of paper	S		69
ESC_m	Full cutting of paper	S		70
GS_V	Cutting the paper	S·P	○	71

OBar Code Commands

Command	Function	MODE	GS P	Page
GS_H	Selecting of printing position of HRI characters	S·P		72
GS_f	Selecting the font of HRI characters	S·P		73
GS_h	Specifying the height of the bar code	S·P		74
GS_k	Printing the bar code	S·P		75
GS_w	Specifying the horizontal size (magnification) of bar code	S·P		81

OCommands for Non-volatile Memory

Command	Function	MODE	GS P	Page
GS (C	Editing user NV memory	S		82
FS_p	Printing the download NV bit images	S		89
FS_q	Defining the download NV bit image	S		88

OPrinter Function Setting Commands

Command	Function	MODE	GS P	Page
GS (E	Printer function setting command	S		92
GS (K	Selecting print control method	S		113
GS (M	Customizing the printer	S		116
GS (N	Designating font attribute	S		119

OSpecial Commands

Command	Function	MODE	GS P	Page
ESC_n	Setting the remaining amount of printout	S		120
ESC_Y	Specifying length of paper feed after black mark detection	S		120
GS_R_0	Collect the receipt	S		121
GS_R_1	Setting receipt collection timer	S		121
GS_S	Detecting a black mark	S		122
FS (L	Controlling black mark paper	S		123

Other Commands

Command	Function	MODE	GS P	Page
DLE ENQ	Real-time request to printer	S·P		126
DLE DC4	Buffer clear	S·P		127
ESC =	Data input control	S·P		128
ESC @	Initializing the printer	S·P		129
ESC L	Selecting PAGE MODE	S		130
ESC S	Selecting STANDARD MODE	P		131
ESC RS	Sound buzzer	S·P		131
GS (A	Execution of test printing	S		132
GS I	Sending the printer ID	S·P		133
GS P	Specifying the basic calculation pitch	S·P		135
GS (L GS 8 L	Specifying graphics data	S		136
GS C 0	Setting counter print mode	S·P		144
GS C 1	Setting counter mode (A)	S·P		145
GS C 2	Setting counter value	S·P		145
GS C :	Setting counter mode (B)	S·P		146
GS c	Print the counter	S·P		146

In the Mode column: S = STANDARD MODE, P = PAGE MODE
 O = shows the command affected by GS P.

2.1.1 Description of Items

XXXX

- [Function]** The name of a command.
- [Code]** The string of codes comprising the command is represented by < >H for hexadecimal numbers, < >B for binary numbers, and < > for decimal numbers, [] k denotes the number of repetition of "k" times.
- [Range]** Indicates the values (setting range) of arguments of the command.
Note: If values outside the defined domain specified with control codes are used, malfunctions could possibly occur, so be sure to use the values within the defined domain.
- [Outline]** Describes the functions of the command.
- [Caution]** Describes important points and cautionary notes, as required.
- [Default]** Initial values for the command if it has arguments.
- [See Also]** Describes commands related to the command when it is used.
- [Sample Program]**
Describes examples of coding on Quick-Basic.
* Examples are only for reference. They may vary depending on language and version.
For details, please refer to a manual in your language.
- [Print Results]** Describes the print results obtained by executing the above programs. However, the print results shown are different in scale from actual print results.

2.2 Command Details

2.2.1 Print Control Commands

LF

- [Function]** Printing and paper feed
- [Code]** <0A>H
- [Outline]** Prints data inside the print buffer and feeds paper based on the line feed amount having been set.
- [Caution]** After this command is executed, the beginning of the line is taken as the start position for the next point.
- [See Also]** [ESC2](#), [ESC3](#)

[Sample Program]

```
LPRINT "AAA"; CHR$(&HA);  
LPRINT "BBB"; CHR$(&HA); CHR$(&HA);  
LPRINT "CCC"; CHR$(&HA);
```

[Print Results]

```
AAA ← Print and line feed  
BBB ← Print and line feed  
    ← Line feed only  
CCC ← Print and line feed
```

CR

- [Function]** Back to printing
- [Code]** <0D>H
- [Outline]** (1) When memory switch 1-5 is OFF: This command is ignored.
(2) When memory switch 1-5 is ON: The same operation as LF is executed.
- [See Also]** [LF](#)

[Sample Program]

```
LPRINT "AAA"; CHR$(&HD);  
LPRINT "BBB"; CHR$(&HD);  
LPRINT CHR$(&HD);  
LPRINT "CCC"; CHR$(&HD);
```

[Print Results]

In case of (2)

```
AAA ← Print and line feed  
BBB ← Print and line feed  
    ← Line feed only  
CCC ← Print and line feed
```

FF

- [Function]**
- (1) Printing in PAGE MODE and returning to STANDARD MODE (at the selection of PAGE MODE)
 - (2) Printing of Black mark and paper feeding to the top of the print position (with Black mark paper selected)

[Code] <0C>H

(1) At selection of PAGE MODE

[Outline] Executes a batch printout of the data mapped in the entire print area, and then returns to STANDARD MODE.

- [Caution]**
- All mapped data is erased after printout.
 - The print area set up by ESC W is initialized.
 - This command does not execute a paper cut.
 - After this command is executed, the beginning of the line is taken as the start position for the next print.
 - This command is only effective when the PAGE MODE is selected.

[See Also] [Appendix 4.1.4 "Example of Using PAGE MODE"](#)
[ESC FF](#), [ESC L](#), [ESC S](#)

(2) At selection of Black mark paper (valid only for Black mark specification)

[Outline] This command prints the data in the printer buffer and searches for the head of the next Black mark (Black mark position)

- [Caution]**
- This command does not execute a paper cut.
 - After this command is executed, the beginning of the line is taken as the start position for the next print.

ESC FF

[Function] Printing data in PAGE MODE

[Code] <1B>H<0C>H

[Outline] Executes a batch printout of the data mapped in the entire print area in PAGE MODE.

[Caution]

- This command is only effective when PAGE MODE is selected.
- Mapped data, as well as the ESC T and ESC W settings, and the character mapping position are held even after printing.

[See Also] [Appendix 4.1 "Explanation on PAGE MODE"](#)
[FF](#), [ESC L](#), [ESC S](#)

ESC J n

[Function]	Printing and feeding paper in minimum pitch
[Code]	<1B>H<4A>H<n>
[Range]	$0 \leq n \leq 255$
[Outline]	Prints the data held in the print buffer and feeds paper by [n · basic calculation pitch] inches.
[Caution]	<ul style="list-style-type: none">• After this command is executed, the beginning of the line is taken as the start position for the next print.• The line feed width can be set separately for the STANDARD and PAGE MODES.• This command does not affect the line feed width defined by ESC 2 or ESC 3.• The basic calculation pitch is set by GS P.• Fractions resulting from calculation are corrected with the minimum pitch of the mechanism, and the remainder is omitted.• In STANDARD MODE, this command uses the vertical (paper feed direction) basic calculation pitch (y).• In PAGE MODE, this command acts differently depending on the start point:<ol style="list-style-type: none">(1) If the start point specified by ESC T is top left or bottom right, the command uses the vertical (paper feed direction) basic calculation pitch (y).(2) If the start point specified by ESC T is top right or bottom left, the command uses the horizontal (perpendicular to the paper feed direction) basic calculation pitch (x).• The maximum settable line feed width is 1016 mm (40 inches). A setting greater than this maximum is trimmed to the maximum.
[Default]	The initial value is not defined.
[Sample Program]	Refer to Sample Program and Print Results for ESC 2.

ESC d n

[Function] Printing and feeding the paper by "n" lines

[Code] <1B>H<64>H<n>

[Range] $0 \leq n \leq 255$

[Outline] Prints data in the print buffer and feeds paper by "n" lines. Specified lines do not remain.

[Caution]

- After this command is executed, the beginning of the line is taken as the start position for the next print.
- If [$n \times$ line feed width] exceeds approximately 1016 mm, this command feeds paper by approximately 1016 mm (40 inches).

[Default] The initial value is not defined.

[Sample Program]

```
LPRINT "AAAAA";  
LPRINT CHR$(&H1B);"d";CHR$(2);  
LPRINT "AAAAA";CHR$(&HA);
```

[Print Results]

AAAAA
↓ 2/6-inch line feed
AAAAA

2.2.2 Print Character Commands

CAN

[Function]	Canceling print data in PAGE MODE
[Code]	<18>H
[Outline]	Erases all data contained in the currently effective print area in PAGE MODE.
[Caution]	<ul style="list-style-type: none">• This command is only effective when PAGE MODE is selected.• If the previously established print area overlaps the currently effective print area, the overlapped data in the previously established area will be erased.
[See Also]	Appendix 4.1 "Explanation on PAGE MODE" ESC L , ESC W

ESC SP n

[Function] Setting the right spacing of the character

[Code] <1B>H<20>H<n>

[Range] $0 \leq n \leq 255$

[Outline] Sets the right spacing of character to $[n \times \text{basic calculation pitch}]$ inches.

- [Caution]**
- If the horizontal magnification of character is 2 or more, the right spacing increases with the magnification.
 - Does not affect Kanji.
 - The right spacing can be set separately for the STANDARD and PAGE MODES.
 - The basic calculation pitch is set by GS P. Once defined, the right spacing is not changed if the basic calculation pitch is changed by GS P.
 - Fractions resulting from calculation are corrected with the minimum pitch of the mechanism, and the remainder is omitted.
 - In STANDARD MODE, this command uses the horizontal basic calculation pitch (x).
 - In PAGE MODE, the basic calculation pitch used by this command depends on the start point:
 - (1) If the start point specified by ESC T is top left or bottom right, the command uses the horizontal basic calculation pitch (x).
 - (2) If the start point specified by ESC T is top right or bottom left, the command uses the vertical basic calculation pitch (y).
 - The maximum right spacing is capable of approximately 31.906 mm (255/203 inches). A setting greater than this maximum is trimmed to the maximum.

[Default] $n = 0$

[See Also] [GS P](#)

[Sample Program]

```
LPRINT CHR$(&H1B);" "; CHR$(0);
LPRINT "AAAAA"; CHR$(&HA);
LPRINT CHR$(&H1B);" "; CHR$(1);
LPRINT "AAAAA"; CHR$(&HA);
LPRINT CHR$(&H1B);" "; CHR$(12);
LPRINT "AAAAA"; CHR$(&HA);
```

[Print Results]

```
A A A A A      ← 0-dot space
A A A A A      ← 1-dot space
A A A A A      ← 12-dots space
```

ESC ! n

[Function] Collectively specifying the printing mode

[Code] <1B>H<21>H<n>

[Range] $0 \leq n \leq 255$

[Outline] Printing mode is assigned.

Bit	Function	Value	
		0	1
0	Character Font	Font A (12×24)	Font B(9×17)
1	Undefined	---	---
2	Undefined	---	---
3	Emphasis	Canceled	Specified
4	Double height	Canceled	Specified
5	Double width	Canceled	Specified
6	Undefined	---	---
7	Underline	Canceled	Specified

- [Caution]**
- With double height and double width being specified simultaneously, quadruple characters are created.
 - An underline is attached to the full character width, which, however, is not attached to the part having been skipped by the horizontal tab (HT). Neither is it attached to 90°-right-turned characters.
 - The underline width is as specified by the ESC – command. (The default setting is 1 dot width.)
 - Setting by this command is invalid for Kanji except setting and canceling of enhanced printing.
 - In case characters with different vertical magnification ratios coexist on the same line, they are printed on the same base line.
 - ESC E, ESC M, ESC –, and GS ! can individually set or cancel the mode but the command processed last is valid.
 - Setting or cancelling of enhanced 3rd bit is valid for alphanumeric and kana and kanji. Other print mode is valid only for alphanumeric and kana characters.

[Default] n = 0

[See Also] [ESC E](#), [ESC M](#), [ESC -](#), [GS !](#)

[Sample Program]

```
LPRINT CHR$(&H1B);"!";CHR$(&H00);"H";  
LPRINT CHR$(&H1B);"!";CHR$(&H01);"H";  
LPRINT CHR$(&H1B);"!";CHR$(&H08);"H";  
LPRINT CHR$(&H1B);"!";CHR$(&H10);"H";  
LPRINT CHR$(&H1B);"!";CHR$(&H20);"H";  
LPRINT CHR$(&H1B);"!";CHR$(&H80);"H";  
LPRINT CHR$(&H1B);"!";CHR$(&HB9);"H";  
LPRINT CHR$(&HA);
```

[Print Results]

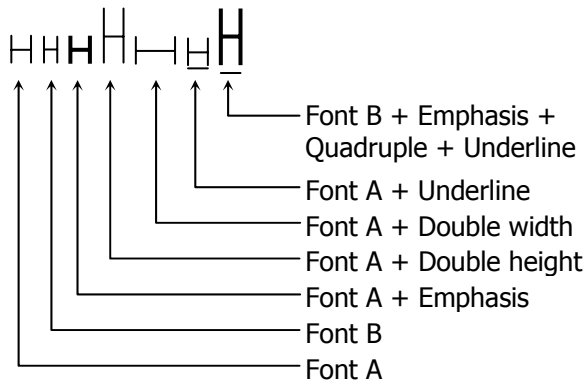

ESC % n

[Function] Specifying/canceling download character set

[Code] <1B>H<25>H<n>

[Range] $0 \leq n \leq 255$

[Outline] Specifying/canceling download characters.

- "n" is valid only for the lowest bit (n0).
- Control by the lowest bit (n0) is shown as follows:

n0	Function
0	Canceling download character set
1	Specifying download character set

[Default] n = 0

[See Also] [ESC &](#)

[Sample Program]

```
GOSUB SETCHR DATA 6
LPRINT CHR$(&H1B);"%";CHR$(0); DATA &HFF,&H80,&H00
LPRINT "@A";CHR$(&HA); DATA &H80,&H80,&H00
LPRINT CHR$(&H1B);"%";CHR$(1); DATA &H80,&H80,&H00
LPRINT "@A";CHR$(&HA); DATA &H80,&H80,&H00
END DATA &HFF,&HFF,&HFF
SETCHR: DATA &HFF,&HFF,&HFF
LPRINT CHR$(&H1B);"&"; DATA 12
LPRINT CHR$(3);"@";"A"; DATA &HFF,&HFF,&HFF
FOR J=1 TO 2 DATA &H80,&H07,&HF9
READ REP DATA &H80,&HFF,&HF9
LPRINT CHR$(REP); DATA &H87,&HFE,&H01
FOR I=1 TO REP*3 DATA &H9F,&H06,&H01
READ D DATA &HF8,&H06,&H01
LPRINT CHR$(D); DATA &HF8,&H06,&H01
NEXT I DATA &H9F,&H06,&H01
NEXT J DATA &H87,&HFE,&H01
RETURN DATA &H80,&HFF,&HF9
DATA &H80,&H07,&HF9
DATA &HFF,&HFF,&HFF
```

[Print Results]

@ A ← Internal character set
□ A ← Download character

ESC & s n m [a [p] s × a] m-n+1

[Function] Defining the download characters

[Code] <1B>H<26>H<s>H<n>H<m>H[<a>H<p1>H<p2>...<ps × a>]m-n+1

[Range] s=3(FontA, B) s=2(FontC)
 $32 \leq n \leq m \leq 126$
 $0 \leq a \leq 12$ (FontA), $0 \leq a \leq 9$ (FontB), $0 \leq a \leq 8$ (FontC)
 $0 \leq p1 \dots ps \times a \leq 255$

[Outline] Defines the font of download characters of alphanumeric characters.

- "s" indicates the number of bytes in vertical direction. "n" indicates the start character code and "m" the end character code. To define only one character, set n = m. Character codes definable includes 95 ASCII codes in total in the range of <20>H to <7E>H.
- "a" indicates the number of dots to be defined in horizontal direction. "p" is the data to be defined, which indicate a pattern equal to "a" dots in horizontal direction from the left end. The rest of the pattern on the right side is filled with space.
- The number of data to be defined is "s : a". Download characters thus defined remain valid until redefinition, execution of ESC @, GS *, FS q, GS (A, deletion by ESC ?, or power OFF is performed.

[Caution] Download characters and download bit images cannot be defined simultaneously. Running this command clears the definition of the download bit image.

[Default] Same as the internal character set.

[See Also] [ESC %](#), [ESC ?](#)

[Example]

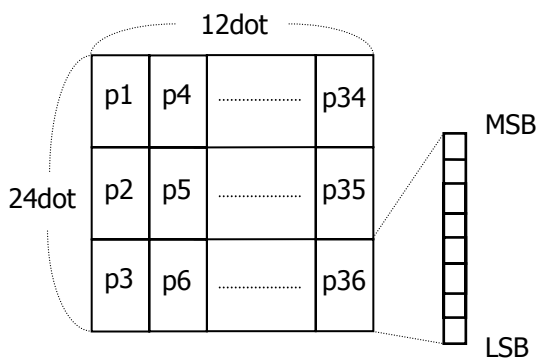

FontA

Create each data bit by setting "1" for a printed dot and "0" for an unprinted dot.

[Sample Program]

[Refer to Sample Program and Print Results for ESC %.](#)

ESC – n

[Function] Specifying/canceling underline

[Code] <1B>H<2D>H<n>

[Range] $0 \leq n \leq 2$, $48 \leq n \leq 50$

[Outline] Specifying/canceling an underline.

n	Function
0,48	Canceling underline
1,49	Setting 1-dot width underline
2,50	Setting 2-dot width underline

- [Caution]**
- An underline is attached to the full character width. It is, however, not attached to the part having been skipped by horizontal tab (HT) command.
 - An underline is not attached to 90°-right-turned characters and white-on-black character.
 - Underline can also be specified/canceled by ESC ! but the setting of command last processed is valid.
 - Specifying/canceling by this command is not valid for kanji.
 - Underline width is constant in the specified thickness regardless of the character size.

[Default] n = 0

[See Also] [ESC !](#), [FS -](#)

[Sample Program]

```
LPRINT CHR$(&H1B);"-";CHR$(0);  
LPRINT "AAAAA";  
LPRINT CHR$(&H1B);"-";CHR$(1);  
LPRINT "AAAAA";CHR$(&HA);
```

[Print Results]

```
Underline canceled  
A A A A A A A A A A  
Underline specified
```

ESC ? n

[Function] Deleting download characters

[Code] <1B>H<3F>H<n>

[Range] $32 \leq n \leq 126$

[Outline] Deletes the downloaded characters of specified code.

[Caution]

- The character “n” indicates the character code used to delete the defined pattern. After the deletion, characters are printed in the same pattern as the internal characters.
- This command deletes the code-defined pattern of the character font selected by ESC !.
- This command is ignored if the specified character code is undefined.

[See Also] [ESC &](#), [ESC %](#)

ESC E n

[Function] Specifying/canceling emphasis printing

[Code] <1B>H<45>H<n>

[Range] $0 \leq n \leq 255$

[Outline] Specifying/canceling the emphasized characters.

- "n" is valid only for the lowest bit (n0).
- Control by the lowest bit (n0) is shown as follows:

n0	Function
0	Canceling emphasis printing
1	Specifying emphasis printing

[Caution]

- Emphasis printing can also be specified/canceled by ESC ! but the setting of command last processed is valid.
- Valid for all character types except HRI characters.

[Default] n = 0

[See Also] [ESC !](#)

[Sample Program]

```
LPRINT CHR$(&H1B);"E"; CHR$(0);  
LPRINT "AAABBB"; CHR$(&HA);  
LPRINT CHR$(&H1B);"E"; CHR$(1);  
LPRINT "AAABBB"; CHR$(&HA);
```

[Print Results]

```
A A A B B B ← Emphasis canceled  
A A A B B B ← Emphasis specified
```

ESC G n

[Function] Specifying/canceling double strike printing

[Code] <1B>H<47>H<n>

[Range] $0 \leq n \leq 255$

[Outline] Specifying/canceling the double strike printing.

- "n" is valid only for the lowest bit (n0).
- Control by the lowest bit (n0) is shown as follows:

n0	Function
0	Canceling double strike printing
1	Specifying double strike printing

[Caution]

- With this printer, double-strike printing and emphasis printing provide completely the same results.
- Valid for all character types except HRI characters.

[Default] n=0

[See Also] [ESC E](#)

[Sample Program]

```
LPRINT CHR$(&H1B);"G"; CHR$(0);  
LPRINT "AAABBB"; CHR$(&HA);  
LPRINT CHR$(&H1B);"G"; CHR$(1);  
LPRINT "AAABBB"; CHR$(&HA);
```

[Print Results]

```
A A A B B B ← Double strike printing canceled  
A A A B B B ← Double strike printing specified
```

ESC M n

[Function] Selection of character fonts

[Code] <1B>H<4D>H<n>

[Range] $0 \leq n \leq 2$, $48 \leq n \leq 50$

[Outline] Selects character fonts.

n	Function
0,48	Selection of font A (12×24)
1,49	Selection of font B (9×24)
2,50	Selection of font C (8×16)

[Caution] ESC ! can also select fonts, but the setting made by the command that has last been processed becomes valid.

[Default] n=0

[See Also] [ESC !](#)

ESC R n

[Function] Selecting the international character set

[Code] <1B>H<52>H<n>

[Range] $0 \leq n \leq 13$

[Outline] Depending on the value of "n", one of the following character sets is specified;

n	Character Set	n	Character Set
0	U.S.A	7	Spain I
1	France	8	Japan
2	Germany	9	Norway
3	U.K	10	Denmark II
4	Denmark I	11	Spain II
5	Sweden	12	Latin America
6	Italy	13	Korea

[Default] n = 0 (Overseas), n = 8 (Domestic)

[See Also] [3.2 "International Character Code Table"](#)

ESC V n

[Function] Specifying/canceling 90°-right-turned characters

[Code] <1B>H<56>H<n>

[Range] $0 \leq n \leq 2$, $48 \leq n \leq 50$

[Outline] Specifying/canceling 90°-right-turned characters.

n	Function
0,48	Canceling 90°-right-turned characters
1,49 2,50	Specifying 90°-right-turned characters

[Caution]

- No underlines are attached to 90°-right-turned characters.
- This command does not affect PAGE MODE but setting is maintained.

[Default] n=0

[Sample Program]

```
LPRINT CHR$(&H1B);"V"; CHR$(0);  
LPRINT "AAAAA";  
LPRINT CHR$(&H1B);"V"; CHR$(1);  
LPRINT "AAAAA"; CHR$(&HA);
```

[Print Results]

AAAAA
90° rotation canceled

➤➤➤➤➤
90° rotation specified

ESC t n

[Function] Selecting the character code table

[Code] <1B>H<74>H<n>

[Range] $0 \leq n \leq 9$, $16 \leq n \leq 19$, $n = 26, 40, 255$

[Outline] Selecting the character code table.
The character code table is selected based on the value of "n".

n	Character Code Table	n	Character Code Table
0	Code page PC437	7,17	Code page PC866
1	Katakana	8	Code page PC857
2	Code page PC850	9,16	Windows code
3	Code page PC860	19	Code page PC858
4	Code page PC863	26	Thai code 18
5	Code page PC865	40	CodepagePC864
6,18	Code page PC852	255	Space page (For user setting)

[Default] $n = 0$ (Overseas), $n = 1$ (Domestic)

[See Also] [3. "Character Code Table"](#)

[Sample Program]

```
LPRINT CHR$(&H1B);"t"; CHR$(0);
LPRINT "n=0  ";
FOR C=&HB1 TO &HB5
LPRINT CHR$(C);
NEXT C
LPRINT CHR$(&HA);
LPRINT CHR$(&H1B);"t"; CHR$(1);
LPRINT "n=1  ";
FOR C=&HB1 TO &HB5
LPRINT CHR$(C);
NEXT C
LPRINT CHR$(&HA);
```

[Print Results]

```
n=0  ███|tt ← n=0
n=1  747t ← n=1
```

ESC { n

[Function] Specifying/canceling the inverted characters

[Code] <1B>H<7B>H<n>

[Range] $0 \leq n \leq 255$

[Outline] Specifying/canceling inverted characters.

- "n" is valid only for the lowest bit (n0).
- Control by the lowest bit (n0) is shown as follows:

n0	Condition
0	Canceling inverted characters.
1	Specifying inverted characters.

[Caution]

- This command is valid only when it is specified at the beginning of a line.
- This command does not affect the PAGE MODE.

[Default] n = 0

[Sample Program]

```
LPRINT CHR$(&H1B) ;"{"; CHR$(0);  
LPRINT "TEN"; CHR$(&HA);  
LPRINT "ELEVEN"; CHR$(&HA);  
LPRINT CHR$(&H1B) ;"{"; CHR$(1);  
LPRINT "TEN"; CHR$(&HA);  
LPRINT "ELEVEN"; CHR$(&HA);
```

[Print Results]

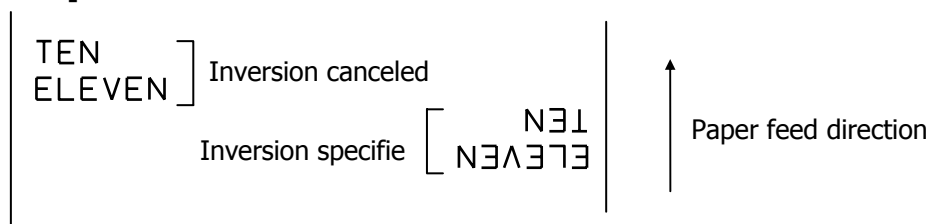

GS ! n

[Function] Specifying the character size

[Code] <1D>H<21>H<n>

[Range] $0 \leq n \leq 255$ where: $1 \leq \text{vertical magnification} \leq 8$, $1 \leq \text{horizontal magnification} \leq 8$

[Outline] Specifies the character size (Vertical and horizontal magnification).

Bit	Function	Value	
		Hex. Number	Decimal Number
0	Vertical magnification specification	Refer to Table 2, "Vertical Magnification".	
1			
2			
3			
4	Horizontal magnification specification	Refer to Table 1, "Horizontal Magnification".	
5			
6			
7			

Table 1 Horizontal Magnification

Hex.	Decimal	Magnification
00	0	1× (Standard)
10	16	2× (Double width)
20	32	3×
30	48	4×
40	64	5×
50	80	6×
60	96	7×
70	112	8×

Table 2 Vertical Magnification

Hex.	Decimal	Magnification
00	0	1× (Standard)
01	1	2× (Double)
02	2	3×
03	3	4×
04	4	5×
05	5	6×
06	6	7×
07	7	8×

- [Caution]**
- This command is valid for all characters (alphanumeric, kana, and kanji) except for HRI characters.
 - This command is ignored if either the vertical magnification or horizontal magnification is out of the defined range.
 - In STANDARD MODE, the vertical direction is defined as the paper feed direction, and the horizontal direction is defined as the direction perpendicular to the paper feed.
 - Setting memory SW 3-7 to ON allows the horizontal and vertical relations to be interchanged when 90°-right-turning of character is specified.
 - In PAGE MODE, the vertical direction means the top-bottom direction of each character. The horizontal direction means the side-to-side direction of each character.
 - If characters of different vertical magnification are contained in a line, the baseline of each character is lined up.
 - Horizontal and vertical magnification can also be specified/canceled by ESC ! but the setting of command last processed is valid.

[Default] $n=0$

[See Also] [ESC !](#)

GS B n

[Function] Specifying/canceling the black/white inverted printing

[Code] <1D>H<42>H<n>

[Range] $0 \leq n \leq 255$

[Outline] This command specifies or cancels the black/white inverted printing.

- "n" is valid only for the lowest bit (n0).
- Control by the lowest bit (n0) is shown as follows:

n0	Function
0	The black/white inverted printing is canceled.
1	The black/white inverted printing is specified.

- [Caution]**
- The black/white inversion works on internal and downloaded characters.
 - The black/white inversion works also on the right spacing of characters defined by ESC SP.
 - This command does not affect the bit image, downloaded bit image, bar code, HRI characters, or the skip area specified by HT, ESC \$, or ESC \.
 - This command does not affect the space between lines.
 - Black/white inversion specification takes precedence over underline specification. Underline printing specified is, therefore, nullified if black/white inversion is specified; the underline setting, however, remains unchanged.

[Default] n=0

GS b n

[Function] Specifying/canceling the smoothing

[Code] <1D>H<62>H<n>

[Range] $0 \leq n \leq 255$

[Outline] This command specifies or cancels the smoothing.

- “n” is valid only for the lowest bit (n0).
- Control by the lowest bit (n0) is shown as follows:

n0	Function
0	The smoothing is canceled.
1	The smoothing is specified.

[Caution]

- Smoothing is effective to printer’s internal characters, download characters, and non-standard characters.
- Smoothing is not effective to characters with either of their vertical or horizontal magnification is $\times 1$.

[Default] $n=0$

[See Also] [ESC!](#), [GS!](#)

2.2.3 Print Position Commands

HT

- [Function]** Horizontal tab
- [Code]** <09>H
- [Outline]** Shifts the printing position to the next horizontal tab position.
• Ignored when the next horizontal tab position has not been set.
- [Caution]** The horizontal tab position is set by ESC D.
- [Default]** At the selection of font A, tabs are set every 8 characters (at 9th, 17th, 25th, ...) with right space amount of a character set at 0 and horizontal enlargement rate of a character set at 1.
- [See Also]** [ESC D](#)

[Sample Program]

```
LPRINT "012345678901234567890"; CHR$(&HA);  
LPRINT CHR$(&H9);"AAA";  
LPRINT CHR$(&H9);"BBB"; CHR$(&HA);  
LPRINT CHR$(&H1B);"D";  
LPRINT CHR$(3); CHR$(7); CHR$(14); CHR$(0);  
LPRINT CHR$(&H9);"AAA";  
LPRINT CHR$(&H9);"BBB";  
LPRINT CHR$(&H9);"CCC"; CHR$(&HA);
```

[Printing Result]

```
012345678901234567890  
      AAA   BBB ← Initially set horizontal tab  
AAA BBB   CCC ← When set to the 4th, 8th, and 15th columns
```

ESC \$ n1 n2

[Function] Specifying the absolute positions

[Code] <1B>H<24>H<n1><n2>

[Range] $0 \leq n1 \leq 255$
 $0 \leq n2 \leq 255$

[Outline] The printing start position is specified by the absolute position from the left margin with the number of dots divided by 256 and quotient specified as "n2" and remainder as "n1".
 Therefore, the printing start position is designated as $[(n1+n2 \times 256) \times \text{basic calculation pitch}]$ from the left margin.

[Caution]

- The basic calculation pitch is set by GS P. After the line feed width is set, if the basic calculation by GS P leaves a fraction, the fraction is corrected with the minimum pitch of the mechanism, and the remainder is omitted.
- In STANDARD MODE, this command uses the horizontal (paper feed direction) basic calculation pitch (x).
- In PAGE MODE, this command acts differently depending on the start point:
 - (1) If the start point specified by ESC T is top right or bottom left, the command uses the vertical (paper feed direction) basic calculation pitch (y).
 - (2) If the start point specified by ESC T is top left or bottom right, the command uses the horizontal (perpendicular to the paper feed direction) basic calculation pitch (x). Specification beyond the end of the line is ignored.

[See Also] [ESC \](#), [GS P](#), [GS \](#), [GS \\$](#)

[Sample Program]

```
LPRINT CHR$(&H1B);"$";
LPRINT CHR$(0); CHR$(0);"A";
LPRINT CHR$(&H1B);"$";
LPRINT CHR$(50); CHR$(0);"B";
LPRINT CHR$(&H1B);"$";
LPRINT CHR$(0); CHR$(1);"C"; CHR$(&HA);
LPRINT CHR$(&H1B);"$";
LPRINT CHR$(100); CHR$(0);"A";
LPRINT CHR$(&H1B);"\";
LPRINT CHR$(&HC2); CHR$(&HFF);"B"; CHR$(&HA)
```

[Print Results]

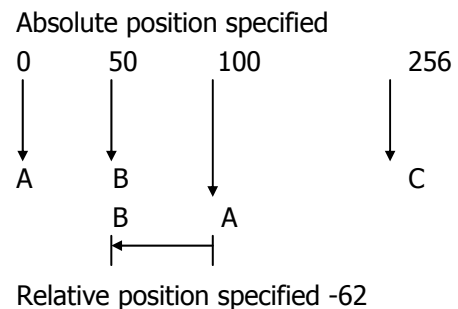

ESC D [n]k NULL

[Function] Setting horizontal tab position

[Code] <1B>H<44>H [<n>] k <00>H

[Range] $1 \leq n \leq 255$
 $0 \leq k \leq 32$

[Outline] Specifying a horizontal tab position.

- "n" indicates the number of columns from the beginning to the horizontal tab position. Note, however, that "n = set position - 1". For example, to set the position at 9th column, n = 8 is to be specified.
- "k" denotes the number of horizontal tab positions you want to set. The tab position is set at a position where it is "character width × n" from the beginning of a line. The character width, at this time, includes the space on the right. In double width characters, it is made double the ordinary case. Tab positions that can be specified are maximum 32. Specifying tab positions exceeding this limit is ignored. <n>k, which denotes a setting position, is input in the increasing order and ends at <00> H.
- ESC D <NULL> clears all the set tab positions. Following clearing, the horizontal tab (HT) command is ignored.

[Caution]

- When the data, <n>k, is equal to or smaller than its preceding data, <n>k-1, it is assumed that tab setting is finished. If this is the case, the next data onward will be processed as normal data.
- When the data, <n>k, exceeds a 1-line print area, set the horizontal tab position, as "Set column position = Maximum print columns + 1".
- The horizontal tab position does not change even if the character width is altered after setting the horizontal tab position.

[Default] At the selection of font A, tabs are set every 8 characters (at 9th, 17th, 25th, ...) with right space amount of a character set at 0 and horizontal enlargement rate of a character set at 1.

[See Also] [HT](#)

[Sample Program]

[Refer to Sample Program and Print Results for HT.](#)

ESC T n

[Function] Selecting the character printing direction in PAGE MODE

[Code] <1B>H<54>H<n>

[Range] $0 \leq n \leq 3$, $48 \leq n \leq 51$

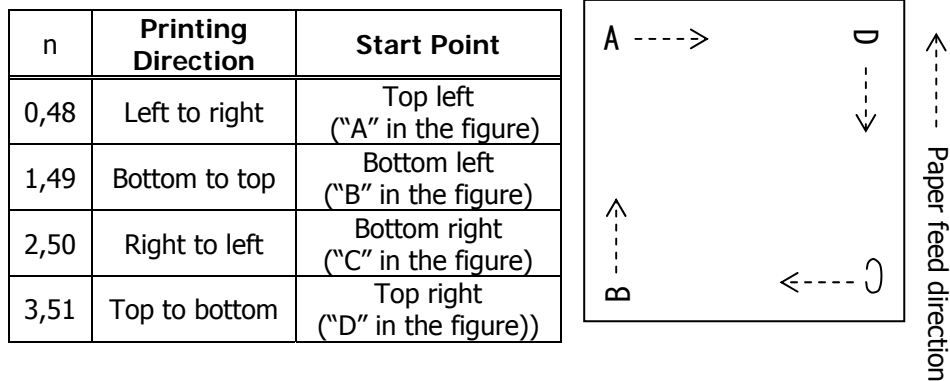

[Outline] Selects the direction and start point of character printing in PAGE MODE.

- [Caution]**
- When STANDARD MODE is selected, this command only executes the internal flagging of the printer without affecting the printing in STANDARD MODE.
 - The character mapping position will be the start point of the print area specified by ESC W.
 - The basic calculation pitch (x or y) used by the following commands varies with the start point.
 - (1) If the start point is the top left or bottom right (the characters are mapped in the direction perpendicular to the paper feed),
 - Commands using x: ESC SP, ESC S, ESC \
 - Commands using y: ESC 3, ESC J, GS \$, GS \
 - (2) If the start point is the top right or bottom left (the characters are mapped in the paper feed direction),
 - Commands using x: ESC 3, ESC J, GS \$, GS \
 - Commands using y: ESC SP, ESC S, ESC \

[Default] n=0

[See Also] [Appendix 4.1 "Explanation on PAGE MODE"](#)
[ESC \\$](#), [ESC L](#), [ESC W](#), [ESC \](#), [GS \\$](#), [GS P](#), [GS \](#)

ESC W xL xH yL yH dxL dxH dyL dyH

[Function]	Defining the print area in PAGE MODE
[Code]	<1B>H<57>H<xL><xH><yL><yH><dxL><dxH><dyL><dyH>
[Range]	$0 \leq xL, xH, yL, yH, dxL, dxH, dyL, dyH \leq 255$ except for $dxL=dxH=0$ or $dyL=dyH=0$
[Outline]	Defines the location and size of the print area. <ul style="list-style-type: none">• Horizontal start point = $[(xL + xH \times 256) \times \text{basic calculation pitch}]$ inches• Vertical start point = $[(yL + yH \times 256) \times \text{basic calculation pitch}]$ inches• Horizontal length = $[(dxL + dxH \times 256) \times \text{basic calculation pitch}]$ inches• Vertical length = $[(dyL + dyH \times 256) \times \text{basic calculation pitch}]$ inches
[Caution]	<ul style="list-style-type: none">• When STANDARD MODE is selected, this command only executes the internal flagging of the printer without affecting the printing in STANDARD MODE.• If the horizontal start point or vertical start point is out of the printable area, this command is canceled and the next data is handled as normal data.• If the horizontal length or vertical length is 0, this command is canceled and the next data is handled as normal data.• The character mapping position will be the start point specified by ESC T in the print area.• If the "horizontal start point + horizontal length" is greater than the horizontal printable area, the "horizontal printable area – horizontal start point" is taken as the horizontal length.• If the "vertical start point + vertical length" is greater than the vertical printable area, the "vertical printable area – vertical start point" is taken as the vertical length.• The basic calculation pitch is defined by GS P. Once defined, the print area is not changed if the basic calculation pitch is changed by GS P.• Fractions resulting from calculations are corrected with the minimum pitch of the mechanism, and the remainder is omitted.• The horizontal start point and horizontal length are calculated with the basic calculation pitch (x). The vertical start point and vertical length are calculated with the basic calculation pitch (y).• The figure below illustrates the print area, where X = horizontal start point, Y = vertical start point, Dx = horizontal length, and Dy = vertical length.

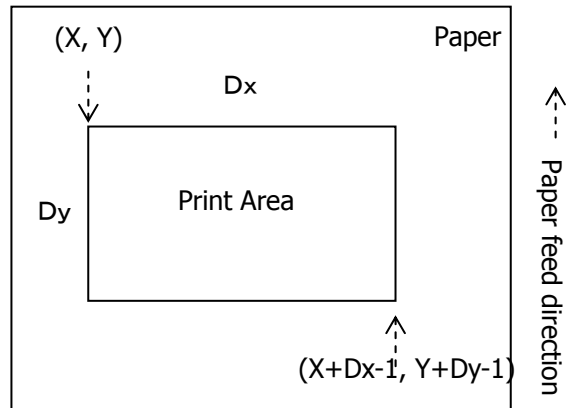

The printable area for this printer is approximately 80.078 mm (640/203 inches) horizontally and 117 mm (938/203 inches) vertically.

[Default] $xL=xH=yL=yH=0$, $dxL=64$, $dxH=2$, $dyL=126$, $dyH=6$

[See Also] [Appendix 4.1 "Explanation on PAGE MODE"](#)
[CAN](#), [ESC L](#), [ESC T](#), [GS P](#)

ESC \ nL nH

[Function] Specifying the relative position

[Code] <1B>H<5C>H<nL><nH>

[Range] $0 \leq nL \leq 255$
 $0 \leq nH \leq 255$

[Outline] This command specifies the next print start position in a relative position with respect to the current position. The next print start position will be at a point of $[(nL+nH \times 256) \times \text{basic calculation pitch}]$ inches away from the current position.

[Caution]

- Specification of a position outside the print area is ignored.
- If a new position is specified to the right of the current position in the direction of printing, it should be specified as positive (+). If it is to the left, it should be as negative (-).
- A negative value is the complement of 65536. For example, to move the position by N pitches to the left, specify it as:
$$nL+nH \times 256 = 65536 - N$$
- The basic calculation pitch is set by GS P.
- Fractions resulting from calculation are corrected with the minimum pitch of the mechanism, and the remainder is omitted.
- In STANDARD MODE, this command uses the horizontal basic calculation pitch (x).
- In PAGE MODE, this command acts differently depending on the start point:
 - (1) If the start point specified by ESC T is top left or bottom right, the command specifies the relative position in the direction perpendicular to the paper feed (the character's side-to-side direction), using the horizontal basic calculation pitch (x).
 - (2) If the start point is top right or bottom left, the command specifies the relative position in the paper feed direction (the character's side-to-side direction), using the vertical basic calculation pitch (y).

[See Also] ESC \$, GS P

[Sample Program]

[Refer to Sample Program and Print Results for ESC \\$.](#)

ESC a n

[Function] Aligning the characters

[Code] <1B>H<61>H<n>

[Range] $0 \leq n \leq 2$, $48 \leq n \leq 50$

[Outline] All the printed data within one line are aligned in the specified position.
Depending on the value "n", positional alignment is carried out as shown in the table below:

n	Position
0,48	Left end alignment
1,49	Centering
2,50	Right end alignment

[Caution] • This command is valid only when it is inputted at the beginning of a line.
• This command does not affect the PAGE MODE.
• Executes justification in the print area being set.

[Default] n=0

[Sample Program]

```
LPRINT CHR$(&H1B);"a"; CHR$(0);  
LPRINT "AAAAA"; CHR$(&HA);  
LPRINT CHR$(&H1B);"a"; CHR$(1);  
LPRINT "AAAAA"; CHR$(&HA);  
LPRINT CHR$(&H1B);"a"; CHR$(2);  
LPRINT "AAAAA"; CHR$(&HA);
```

[Print Results]



GS \$ nL nH

[Function]	Specifying the absolute vertical position of characters in PAGE MODE
[Code]	<1D>H<24>H<nL><nH>
[Range]	$0 \leq nL \leq 255$, $0 \leq nH \leq 255$
[Outline]	Specifies the vertical position of character at the start point of data development in PAGE MODE using absolute position based on the start position. The position of vertical direction of character at the start position of next data development is the position [(nL + nH × 256) × basic calculation pitch] from the start position.
[Caution]	<ul style="list-style-type: none">• This command is ignored except at PAGE MODE selection.• Absolute position setting exceeding the specified print area is ignored.• Position in horizontal direction of character at the start position of data development is not shifted.• Start point used as the reference is set by ESC T.• The following operation occurs at the start point of ESC T.<ol style="list-style-type: none">(1) When start point is set at upper left or lower right, the absolute position of paper feed direction (vertical direction of character) is set. In this case, basic calculation pitch (y) of vertical direction is used.(2) When start point is set at upper right or lower left, the absolute position of vertical direction of paper feed (vertical direction of character) is set. In this case, basic calculation pitch (x) of horizontal direction is used.• Basic calculation pitch is set by GS P.• When fractional number is caused by the calculation, it is corrected by the minimum pitch of mechanism and the rest is discarded.
[See Also]	ESC \$, ESC T , ESC W , ESC \ , GS P , GS \

GS L nL nH

[Function] Setting the left margin

[Code] <1D>H<4C>H<nL><nH>

[Range] $0 \leq nL \leq 255$, $0 \leq nH \leq 255$

[Outline] This command sets the left margin specified by nL and nH.
The value of the left margin is $[(nL+nH \times 256) \times \text{basic calculation pitch}]$ inches.

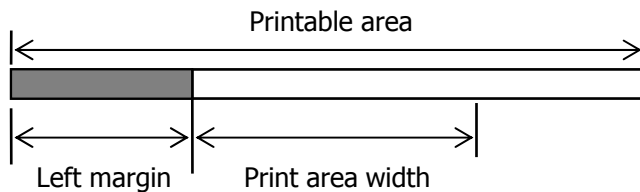

- [Caution]**
- This command only works when it is entered at the beginning of a line.
 - When PAGE MODE is selected, this command only executes the internal flagging of the printer.
 - The setting of this command does not affect PAGE MODE.
 - The maximum settable left margin is equal to the horizontal printable area. A setting greater than this maximum is trimmed to the maximum.
 - The basic calculation pitch is defined by GS P. Once defined, the left margin is not changed if the basic calculation pitch is changed by GS P.
 - The left margin is calculated with the horizontal basic calculation pitch (x) set by GS P. A fraction resulting from the calculation is corrected with the minimum pitch of the mechanism, and the remainder is omitted.
 - When mapping character data, if the print area specified is not wide enough to accommodate one character of the current font, only the line for that character data is handled as follows:
 - (1) The print area is extended toward the right to be equivalent to one character of the current font, but not wider than the printable area.
 - (2) If an area for one character cannot be provided as a result of step (1), the print area is extended toward the left. (So, the left margin is decreased.)
 - When mapping non-character data (bit image, downloaded bit image, raster bit image, or NV bit image), if the print area specified is narrower than 9-bits, only the line for that data is handled as follows:
 - (1) The print area is extended toward the left (so, the left margin is decreased) until it is 9-dot wide, but not wider than the printable area.

[Default] nL=0, nH=0

[See Also] [GS P](#), [GS W](#)

GS T n

[Function] Moving print position to top of the line

[Code] <1D>H<54>H<n>

[Range] n=0, 1, 48, 49

[Outline] Moves print position to top of the line.

- "n" specifies data processing in print buffer at the execution of this command.

n	Function
0,48	Moves print position after erasing the data in print buffer.
1,49	Moves print position after printing the data in print buffer.

- When printing is specified (n = 1, 49), data in the print buffer is printed and line feeding in accordance with the specified line feed is executed.
- When erasing is specified (n = 0, 48), cancel processing of print data in the print buffer is executed with other data and setting retained.

GS W nL nH

[Function] Setting the print area width

[Code] <1D>H<57>H<nL><nH>

[Range] $0 \leq nL \leq 255$
 $0 \leq nH \leq 255$

[Outline] Sets the print area width specified by nL and nH.
 • The print area width will be $[(nL+nH \times 256) \times \text{basic calculation pitch}]$ inches.

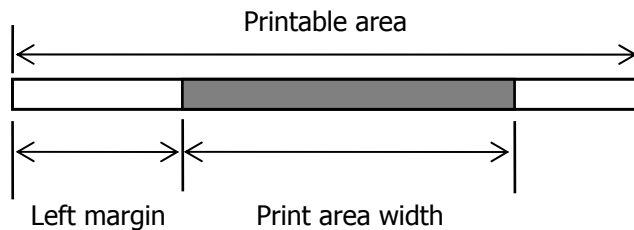

- [Caution]**
- This command only works when it is entered at the beginning of a line.
 - When PAGE MODE is selected, this command only executes the internal flagging of the printer.
 - The setting of this command does not affect PAGE MODE.
 - If the value entered with this command exceeds the printable area for one line, the entire area except the left margin is set as the print area width.
 - The basic calculation pitches are defined by GS P. Once defined, the print area width is not changed if the basic calculation pitch is changed by GS P.
 - The print area width is calculated with the horizontal basic calculation pitch (x) defined by GS P. A fraction resulting from the calculation is corrected with the minimum pitch of the mechanism, and the remainder is omitted.
 - If the first character to be mapped at the beginning of a line has a width (including the right spacing) greater than the print area width, only that line is handled as follows:
 - (1) The print area is extended toward the right to accommodate the first character, but not wider than the printable area.

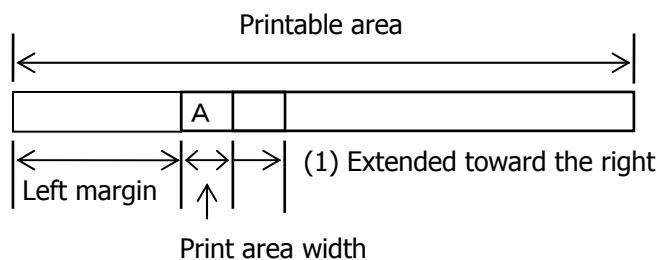

(2) If a sufficient area cannot be provided as a result of step (1), the print area is extended toward the left (so, the left margin is decreased).

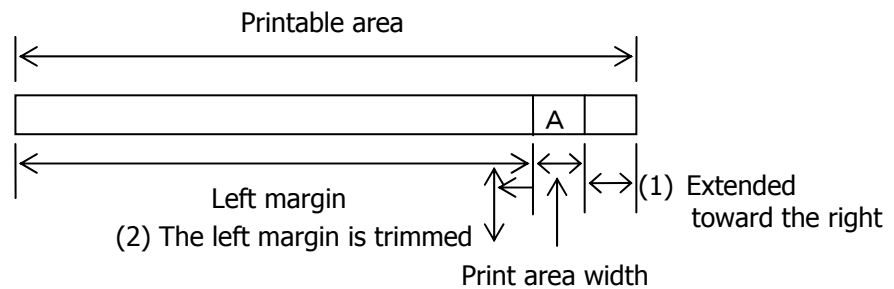

(3) If a sufficient area cannot be provided as a result of step (2), the right spacing is trimmed.

- When mapping a bit image (or downloaded bit image), if the print area is narrower than the minimum width of the bit image (two dots for single density, or one dot for double density), only the line for that image is handled as follows:
 - (1) The print area is extended toward the left (so, the left margin is decreased) until it is equal to the minimum width of the image, but not wider than the printable area.

[Default] nL=64、nH=2

[See Also] [GSL](#), [GSP](#)

GS \ nL nH

[Function]	Specifying the relative vertical position of a character in PAGE MODE
[Code]	<1D>H<5C>H<nL><nH>
[Range]	$0 \leq nL \leq 255$, $0 \leq nH \leq 255$
[Outline]	This command is used in PAGE MODE to specify the vertical position of a character in the data mapping start position, in a relative position with respect to the current position. The next data mapping start position will be at a point $[(nL+nH \times 256) \times \text{basic calculation pitch}]$ inches away from the current position.
[Caution]	<ul style="list-style-type: none">• This command is ignored when PAGE MODE is not selected.• If a new position is specified for a character located beneath the current position, it should be specified as positive (+). If it is above the current position, it should be negative (-).• A negative value is the complement of 65536. For example, to move the position by N pitches up, specify it as: $nL+nH \times 256 = 65536 - N$• The specification of a relative position outside the specified print area is ignored.• Depending on the start point specified by ESC T, this command acts as follows:<ol style="list-style-type: none">(1) If the start point is the top left or bottom right, the command specifies the relative position in the paper feed direction (the character's top-bottom direction) using the vertical basic calculation pitch (y).(2) If the start point is the top right or bottom left, the command specifies the relative position in the direction perpendicular to the paper feed (the character's top-bottom direction) using the horizontal basic calculation pitch (x).• The basic calculation pitch is set by GS P.• Fractions resulting from calculations are corrected with the minimum pitch of the mechanism, and the remainder is omitted.

2.2.4 Line Feed Span Commands

ESC 2

[Function] Specifying 1/6-inch line feed rate

[Code] <1B>H<32>H

[Outline] The line feed rate per line is specified by 1/6 inch.

[Caution] Line feed rate can be specified respectively for both STANDARD MODE and PAGE MODE.

[Sample Program]

```
LPRINT "AAAAA";CHR$(&HA);  
LPRINT CHR$(&H1B);"3";CHR$(0);  
LPRINT "AAAAA";CHR$(&HA);  
LPRINT CHR$(&H1B);"3";CHR$(50);  
LPRINT "AAAAA";CHR$(&HA);  
LPRINT CHR$(&H1B);"2";  
LPRINT "AAAAA";CHR$(&HA);  
LPRINT "AAAAA";  
LPRINT CHR$(&H1B);"J";CHR$(100);  
LPRINT "AAAAA";CHR$(&HA);  
LPRINT "AAAAA";CHR$(&HA);
```

[Print Results]

```
A A A A A  
↑  
1/6-inch line feed  
↓  
A A A A A  
↑  
0/360-inch line feed  
↓  
A A A A A  
↑  
50/360-inch line feed  
↓  
A A A A A  
↑  
1/6-inch line feed  
↓  
A A A A A  
↑  
100 /360-inch line feed  
↓  
A A A A A  
↑  
1/6-inch line feed  
↓  
A A A A A
```

ESC 3 n

[Function]	Setting line feed rate of minimum pitch
[Code]	<1B>H<33>H<n>
[Range]	$0 \leq n \leq 255$
[Outline]	Sets the line feed width per line to [n · basic calculation pitch] inches.
[Caution]	<ul style="list-style-type: none">• The line feed width can be set separately for the STANDARD and PAGE MODES.• The basic calculation pitch is set by GS P. Once defined, the line feed width is not changed if the basic calculation pitch is changed by GS P.• Fractions resulting from calculation are corrected with the minimum pitch of the mechanism, and the remainder is omitted.• In STANDARD MODE, this command uses the vertical (paper feed direction) basic calculation pitch (y).• In PAGE MODE, this command acts differently depending on the start point:<ol style="list-style-type: none">(1) If the start point specified by ESC T is top left or bottom right, the command uses the vertical (paper feed direction) basic calculation pitch (y).(2) If the start point specified by ESC T is top right or bottom left, the command uses the horizontal (perpendicular to the paper feed direction) basic calculation pitch (x).• The maximum settable line feed width is 1016 mm (40 inches). A setting greater than this maximum is trimmed to the maximum.
[Default]	When memory switch 3-7 is OFF: Line feed is approx. 4.23 mm. When memory switch 3-7 is ON: Line feed is approx. 3.75 mm.
[See Also]	ESC 2 , GS P

2.2.5 Bit Image Commands

ESC * m n1 n2 [d]k

[Function] Specifying the bit image mode

[Code] <1B>H<2A>H<m>H<n1><n2>[<d>] k

[Range] m=0, 1, 32, 33
 $0 \leq n1 \leq 255$
 $0 \leq n2 \leq 2$
 $0 \leq d \leq 255$
 $k = n1 + 256 \times n2$ (m=0, 1)
 $k = (n1 + 256 \times n2) \times 3$ (m=32, 33)

[Outline]

- According to the number of dots specified in "n1", "n2", specify the bit image of mode "m".
- The number of dots printed is divided by 256, whose quotient is taken as "n2" and residual as "n1". The total number of dots printed in the horizontal direction is equal to "n1 + (256 · n2)".
- When bit image data have been input in excess of dot positions that can be printed on one line, the excess data are discarded.
- "d" is bit image data. Bits to be printed are specified as "1" and those not as "0".
- The bit image modes specified by "m" are shown as follows:

m	Mode No.	Vertical Direction		Horizontal Direction	
		Dot No.	Density of Dots	Density of Dots	Dot Max.
0	8-dots single density	8	67DPI	101DPI	288
1	8-dots double density	8	67DPI	203DPI	576
32	24-dots single density	24	203DPI	101DPI	288
33	24-dots double density	24	203DPI	203DPI	576

[Caution]

- When the value of "m" is out of the above range, the data following after "n1" is processed as normal printing data.
- After completion of bit image printing, the printer returns to normal data processing mode.

[Sample Program]

```
LPRINT CHR$(&H1B);"*";
LPRINT CHR$(0);CHR$(20);CHR$(0);
GOSUB IMG1
LPRINT CHR$(&HA);
LPRINT CHR$(&H1B);"*";
LPRINT CHR$(1);CHR$(20);CHR$(0);
GOSUB IMG1
LPRINT CHR$(&HA);
LPRINT CHR$(&H1B);"*";
LPRINT CHR$(32);CHR$(20);CHR$(0);
GOSUB IMG2
LPRINT CHR$(&HA);
LPRINT CHR$(&H1B);"*";
LPRINT CHR$(33);CHR$(20);CHR$(0);
GOSUB IMG2
LPRINT CHR$(&HA);
END

IMG1:
LPRINT CHR$(&HFF);
FOR I=1 TO 18
    LPRINT CHR$(&H85);
NEXT I
LPRINT CHR$(&HFF);
RETURN

IMG2:
LPRINT CHR$(&HFF);
LPRINT CHR$(&HFF);
LPRINT CHR$(&HFF);
FOR I=1 TO 18
    LPRINT CHR$(&H80);
    LPRINT CHR$(&H00);
    LPRINT CHR$(&H05);
NEXT I
LPRINT CHR$(&HFF);
LPRINT CHR$(&HFF);
LPRINT CHR$(&HFF);
RETURN
```

[Print Results]

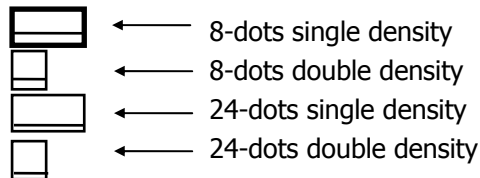

GS * n1 n2 [d] n1 × n2 × 8

[Function] Defining the download bit image

[Code] <1D>H<2A>H<n1><n2>[<d>] n1 × n2 × 8

[Range] $1 \leq n1 \leq 255$
 $1 \leq n2 \leq 48$
 $n1 \times n2 \leq 1536$

[Outline]

- Defines download bit images of the number of dots specified by "n1" and "n2".
- The numbers of dots are "n1 × 8" in horizontal direction and "n2 :8" in vertical direction.
- "d" indicates bit image data.
- Once defined, the download bit image remains effective until it is redefined, ESC @, ESC &, GS (A, or FS q, is executed, or power is turned OFF.

[Caution]

- Relations between the bit image data and the dots defined are shown below.
- With this command executed, the defined content of a downloaded character is cleared.

[See Also] [GS /](#)

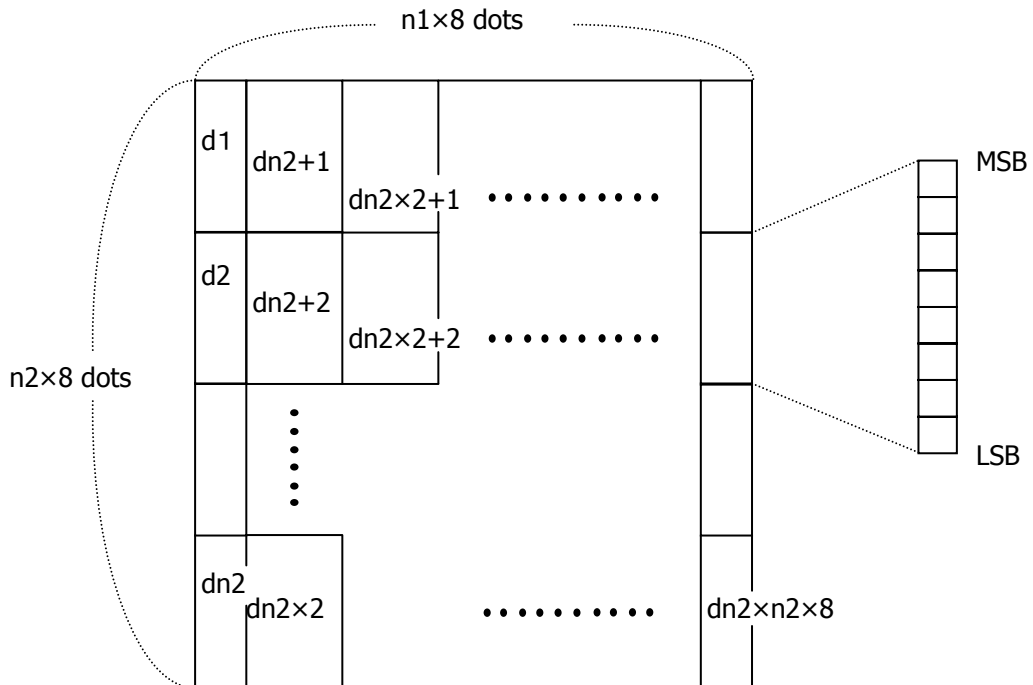

[Sample Program]

```

GOSUB IMG
LPRINT CHR$(&H1D);"/"; CHR$(0);
LPRINT CHR$(&H1D);"/"; CHR$(1);
LPRINT CHR$(&H1D);"/"; CHR$(2);
LPRINT CHR$(&H1D);"/"; CHR$(3);
END
IMG:
n1=10:n2=5
LPRINT CHR$(&H1D);"*";
LPRINT CHR$(n1); CHR$(n2);
FOR J=1 TO n1*8
FOR I=1 TO n2
LPRINT CHR$(J);
NEXT I
NEXT J
RETURN

```

[Print Results]

GS / m

[Function] Printing the downloaded bit image

[Code] <1D>H<2F>H<m>

[Range] $0 \leq m \leq 3$, $48 \leq m \leq 51$

[Outline] Prints downloaded bit image in a mode specified by "m".
Modes that can be selected by "m" are shown below.

m	Mode Name	Dot Density in Vertical Direction	Dot Density in Horizontal Direction
0,48	NORMAL MODE	203DPI	203DPI
1,49	DOUBLE WIDTH MODE	203DPI	101DPI
2,50	DOUBLE HEIGHT MODE	101DPI	203DPI
3,51	QUADRUPLE SIZE MODE	101DPI	101DPI

[Caution]

- When a downloaded bit image has not been defined, this command is ignored.
- When data exist in the print buffer, this command is ignored.
- A portion of a downloaded bit image exceeding one line length is not printed.

[See Also] [ESC &](#), [GS *](#)

GS v 0 m xL xH yL yH d1...dk

[Function] Printing of raster bit image

[Code] <1D>H<76>H<30>H<m><xL><xH><yL><yH> [<d>] k

[Range] $0 \leq m \leq 3$, $48 \leq m \leq 51$, $0 \leq xL \leq 255$, $0 \leq xH \leq 255$, $0 \leq yL \leq 255$, $0 \leq yH \leq 8$, $0 \leq d \leq 255$,
 $k = (xL + xH \times 256) \times (yL + yH \times 256)$ however, $k \neq 0$

[Outline] Prints raster bit images in mode "m".

- xL, xH specify the number of data in horizontal direction of the bit image to $(xL + xH \times 256)$ bytes.
- yL, yH specify the number of data in vertical direction of the bit image to $(yL + yH \times 256)$ bytes.

m	Mode Name	Dot Density in Vertical Direction	Dot Density in Horizontal Direction
0,48	NORMAL MODE	203DPI	203DPI
1,49	DOUBLE WIDTH MODE	203DPI	101DPI
2,50	DOUBLE HEIGHT MODE	101DPI	203DPI
3,51	QUADRUPLE SIZE MODE	101DPI	101DPI

[Caution]

- In STANDARD MODE, this command is valid only when there is no print data in the print buffer.
- Any of the print modes (character size, emphasis, double strike, inverting, underlining, back-to-white reversing, etc.) does not affect the raster bit image.
- If the print area specified by GS L and GS W is narrower than a minimum width, the print area for that line only is extended to the minimum width. The minimum width is one dot in NORMAL MODE (m = 0, 48) and DOUBLE HEIGHT MODE (m = 2, 50), and 2 dots in DOUBLE WIDTH MODE (m = 1, 49) and QUADRUPLE SIZE MODE (m = 3, 51).
- Any part of data that is out of the print area is only read and discarded in units of dot.
- The print start position can arbitrarily be specified with HT, ESC \$, ESC \, and GS L. Note that if the print start position is not a multiple of 8, the printing speed may decrease.
- The setting of ESC a are also valid for the raster bit image.
- If this command is executed during macro definition, the macro definition is suspended, and the processing of the command starts. The macro is left undefined.
- "d" denotes defined data. Dots to be printed are specified as "1", and those not to be printed as "0".

[Example] When $xL + xH \times 256 = 64$

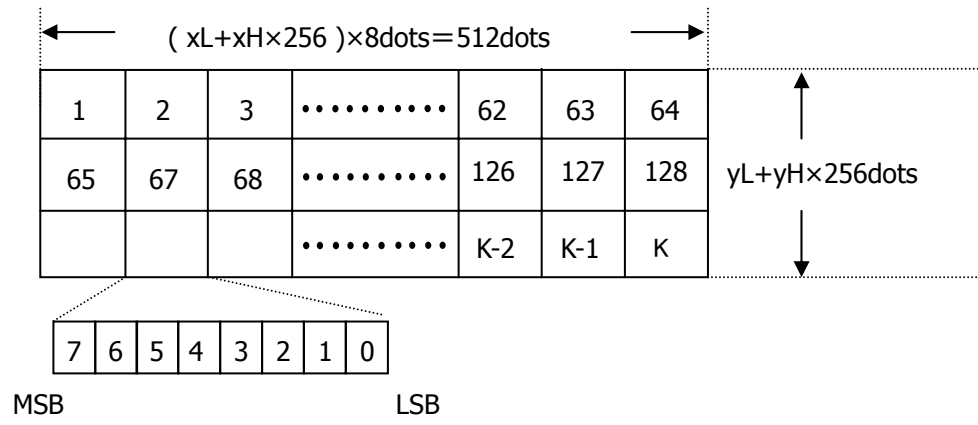

2.2.6 Status Commands

DLE EOT n

[Function] Sending status in real-time

[Code] <10>H<04>H<n>

[Range] $1 \leq n \leq 6$

[Outline] Sends in real-time the status specified by "n".

n	Status
1	Printer status
2	Status caused by an offline condition
3	Status caused by an error
4	Continuous paper sensor
5	Error details 1
6	Error details 2

- [Caution]**
- Each status represents the current status. It is 1 byte data.
 - The status is transferred without checking whether the host is ready to receive or busy.
 - This command is executed even if the printer is in offline state, receive-buffer full state, or error state.
 - This command is dealt with when it is received.
 - With serial interface specifications, this command is executed in offline state, receiving buffer full state, and error state.
 - With parallel interface specifications, this command cannot be executed while the printer is in Busy state. When memory switch 1-3 is ON, the printer does not enter Busy state in the offline state and error state.
 - If ASB (Automatic Status Back) is enabled by GS a, it is necessary to discriminate between the status due to ASB and the status due to this command.
 - This command can be executed even if printer setting by ESC = is invalid.
 - If another data string of <10>H<04>H<n> (1 n 4) is received, the printer acts the same way as with this command. Therefore, the user should be reminded of this fact.
[Example 1]
Suppose a command "ESC * m nL nH [d1...dk]", where d1 = <10>H, d2 = <04>H, d3= <01>H.
 - The DLE EOT n command cannot be interleaved into the code string of another command consisting of 2 bytes or more.
[Example 2]
If the printer sends DLE EOT 3 after the host has sent up to ESC 3 in its attempt to send ESC 3 n, the printer handles the ESC 3 as ESC 3 <10>H. Thus, the user should be cautious.

(1) Printer status (When n = 1 is specified)

Bit	Status	Hex.	Decimal
0	Fixed	00	0
1	Fixed	02	2
2	Fixed	00	0
3	Online status	00	0
	Offline status	08	8
4	Fixed	10	16
5	Not waiting online recovery	00	0
	Waiting online recovery	20	32
6	FEED switch is not pressed	00	0
	FEED switch is pressed	40	64
7	Fixed	00	0

(2) Status caused by an offline condition (When n = 2 is specified)

Bit	Status	Hex.	Decimal
0	Unused	00	0
1	Unused	02	2
2	Cover closed	00	0
	Cover open	04	4
3	Not in paper feed state triggered by FEED switch	00	0
	In paper feed state triggered by FEED switch	08	8
4	Unused	10	16
5	Printing is not stopped because of "paper out" state	00	0
	Printing is stopped because of "paper out" state	20	32
6	Error not occurred	00	0
	Error occurred	40	64
7	Unused	00	0

Bit 5: Printing is stopped if the Paper-end Sensor detects a "paper out" state, or if the printer is out of paper when the Paper Near-end Sensor is enabled by ESC c 4. At this time, bit 5 = 1.

(3) Status caused by an error (When n = 3 is specified)

Bit	Status	Hex.	Decimal
0	Fixed	00	0
1	Fixed	02	2
2	No B.M detection error/Presenter error occurred	00	0
	A B.M detection error/Presenter error occurred	04	4
3	Auto cutter error not occurred	00	0
	Auto cutter error occurred	08	8
4	Fixed	10	16
5	Unrecoverable error not occurred	00	0
	Unrecoverable error occurred	20	32
6	Auto recovery error not occurred	00	0
	Auto recovery error occurred	40	64
7	Fixed	00	0

Bit 3: If this error occurred because of a paper jam, for example, remove the cause of the error, and then DLE ENQ n (1 n 2) can be used to recover from the error. However, it is not possible to recover from any error due to a circuit problem (e.g., broken wire).

Bit 6: If a head overheat error is detected, the printing is stopped until the head temperature falls. At this time, bit 6 = 1.

(4) Continuous paper sensor (When n = 4 is specified)

Bit	Status	Hex.	Decimal
0	Fixed	00	0
1	Fixed	02	02
2	Paper found by Paper Near-end 1 Sensor	00	0
	Paper not found by Paper Near-end 1 Sensor	04	4
3	Paper found by Paper Near-end 2 Sensor	00	0
	Paper not found by Paper Near-end 2 Sensor	08	8
4	Fixed	10	16
5	Paper found by Paper-end Sensor	00	0
	Paper not found by Paper-end Sensor	60	96
6	Paper not found by Presenter Sensor	00	0
	Paper found by Presenter Sensor	40	64
7	Fixed	00	0

(5) Error details 1 (When n = 5 is specified)

Bit	Status	Hex.	Decimal
0	Fixed	0	0
1	Fixed	2	2
2	Cover is closed	00	0
	Cover is open	04	4
3	No head over heat error occurs	00	0
	Head overheat error occurs	08	8
4	Fixed	10	0
5	No low voltage error occurs	00	0
	Low voltage error occurs	20	32
6	No high voltage error occurs	00	0
	High voltage error occurs	40	64
7	Fixed	0	0

(6) Error details 2 (When n = 6 is specified)

Bit	Status	Hex.	Decimal
0	Fixed	0	0
1	Fixed	2	2
2	No memory check error occurs	00	0
	Memory check error occurs	04	4
3	No sum check error occurs	00	0
	Sum check error occurs	08	8
4	Fixed	10	0
5	No presentor error occurs	00	0
	Presentor error occurs	20	32
6	No CPU abnormal error occurs	00	0
	CPU abnormal error occurs	40	64
7	Fixed	0	0

[See Also] [Appendix 4.3 "Identification of Send Status"](#)
[DLE ENQ](#), [ESC c 4](#), [GS a](#), [GS r](#)

ESC v (At Serial I/F Selection)

[Function] Sending printer status

[Code] <1B>H<76>H

[Outline] Sends the current status of the printer.

- [Caution]**
- The status to be sent is one byte and the content is shown in the following table.
 - With DTR/DSR control, after confirming that the host is ready for reception (DSR signal is space), only one byte is transmitted. With XON/XOFF control, only one byte is transmitted without confirmation of DSR signal state.
 - With DTR/DSR, when the host is not ready for reception (DSR signal is mark state), this command waits till reception is ready.
 - As the printer is Busy in the Paper-end state, this command may be in the state not ready for reception.
 - This command is valid only for serial interface.

Bit	Function	Value	
		0	1
0	Paper Near-end 1	With Paper	No Paper
1	Presenter Sensor	No Paper	With Paper
2	Paper-end	With Paper	No Paper
3	Paper Near-end 2	With Paper	No Paper
4	Unused	Fixed	---
5	Undefined	---	---
6	Undefined	---	---
7	Undefined	---	---

[Sample Program]

```
OPEN "COM1:N81NN" AS #1 → OPEN statement differs with the type of BASIC.  
PRINT #1, CHR$(&H1B);"v";  
A$ = INPUT$(1, #1)  
CLOSE #1
```

GS a n

[Function] Enabling/disabling ASB (Automatic Status Back)

[Code] <1D>H<61>H<n>

[Range] $0 \leq n \leq 255$

[Outline] This command selects the status item to be addressed by ASB (Automatic Status Back.)

Bit	Status Item Addressed by ASB	Hex.	Decimal
0	Undefined	—	—
1	Online/offline status = Disabled	00	0
	Online/offline status = Enabled	02	2
2	Error status = Disabled	00	0
	Error status = Enabled	04	4
3	Continuous Paper Sensor = Disabled	00	0
	Continuous Paper Sensor = Enabled	08	8
4	Undefined	—	—
5	Undefined	—	—
6	Undefined	—	—
7	Undefined	—	—

- [Caution]**
- If any status item is enabled, the status is sent to the host when this command is executed. After that time on, the status is sent each time an enabled status item changes. Because each status item represents the current condition, status items disabled for ASB may also have changed.
 - The ASB function is disabled if all status items are disabled.
 - If the ASB function is enabled by default, the host receives the status the first time the printer gets ready for communication after it is turned on.
 - The printer sends 4 bytes of status shown in the tables below, without checking whether the host is ready to receive or busy. The 4 bytes of status is a continuous string except for XOFF code.
 - Because this command is executed when data is mapped in the receive buffer, there may be a delay between command receiving and status sending depending on the condition of the receive buffer.
 - Even if the printer is excluded from the selection of peripheral equipment ESC =, the 4 bytes of status is sent to the host whenever status changes.
 - When DLE EOT, GS I, or GS r is used, the host must discriminate between the status specified by these commands and the status due to ASB.

(1) 1st byte (Printer information)

Bit	Status	Hex.	Decimal
0	Unused	00	0
1	Unused	00	0
2	Unused	00	0
3	Online status	00	0
	Offline status	08	8
4	Unused	10	16
5	Cover closed	00	0
	Cover open	20	32
6	Not in paper feed state triggered by FEED switch	00	0
	In paper feed state triggered by FEED switch	40	64
7	Unused	00	0

(2) 2nd byte (Error occurrence information)

Bit	Status	Hex.	Decimal
0	Undefined	—	—
1	Undefined	—	—
2	No B.M detection error occurred (only when B.M paper is selected)	00	0
	A B.M detection error occurred (only when B.M paper is selected)	04	4
3	Auto cutter error not occurred	00	0
	Auto cutter error occurred	08	8
4	Unused	00	0
5	Unrecoverable error not occurred	00	0
	Unrecoverable error occurred	20	32
6	Auto recovery error not occurred	00	0
	Auto recovery error occurred	40	64
7	Unused	00	0

(3) 3rd byte (Paper Sensor information)

Bit	Status	Hex.	Decimal
0	Paper found by Paper Near-end 1 Sensor	00	0
	Paper not found by Paper Near-end 1 Sensor	01	1
1	Paper found by Paper Near-end 2 Sensor	00	0
	Paper not found by Paper Near-end 2 Sensor	02	2
2	Paper found by Paper End Sensor	00	0
	Paper not found by Paper End Sensor	04	4
3	Paper found by Presenter Sensor	00	0
	Paper not found by Presenter Sensor	08	8
4	Unused	00	0
5	Undefined	—	—
6	Undefined	—	—
7	Unused	00	0

(4) 4th byte (Paper Sensor information)

Bit	Status	Hex.	Decimal
0	Reserved	01	1
1	Reserved	02	2
2	Reserved	04	4
3	Reserved	08	8
4	Fixed	00	0
5	Reserved	00	00
6	Reserved	00	00
7	Fixed	00	0

[Default] When memory switch 1-3 is OFF: n = 0
When memory switch 1-3 is ON: n = 2

[See Also] [DLE EOT](#), [GS r](#)

GS r n

[Function] Sending status

[Code] <1D>H<72>H<n>

[Range] n=1, 49

[Outline] Sends the specified status to the host.

n	Function
1,49	Sends the Paper Sensor status.

[Caution]

- When the serial interface is used:
 - For DTR/DSR control:

The printer sends the status after verifying that the host is ready to receive. If the host is not ready to receive, the printer waits for the host to become ready to receive.
 - For XON/XOFF control:

The printer sends the status without checking whether the host is ready to receive or busy.
- Because this command is executed when data is mapped in the receive buffer, there may be a delay between receiving the command and sending the status depending on the condition of the receive buffer.
- If ASB (Automatic Status Back) is enabled by GS a, the host must discriminate between the status due to this command and the status due to ASB.

• Paper Sensor status (n = 1, 49)

Bit	Status	Hex.	Decimal
0	Paper found by Paper Near-end 1 Sensor	00	0
	Paper not found by Paper Near-end 1 Sensor	01	1
1	Paper found by Paper Near-end 2 Sensor	00	0
	Paper not found by Paper Near-end 2 Sensor	02	2
2	Paper found by Paper-end Sensor	00	0
	Paper not found by Paper-end Sensor	04	4
3	Paper not found by Presenter Sensor	00	0
	Paper found by Presenter Sensor	08	8
4	Unused	00	0
5	Undefined	—	—
6	Undefined	—	—
7	Unused	00	0

Bit 2: Whenever the Paper-end Sensor detects a "paper out" state, the printer goes offline, and the command is not executed. Therefore, the printer never sends a status "No paper in Paper-end detector (04H)".

[See Also] [Appendix 4.3 "Identification of Send Status"](#)
[DLE EOT](#), [GS a](#)

2.2.7 Paper Detecting Commands

ESC c 3 n

[Function] Selecting the Paper Sensor valid for a Paper-end signal output

[Code] <1B>H<63>H<33>H<n>

[Range] $0 \leq n \leq 255$

[Outline] This command selects by which Paper Sensor a Paper-end signal should be output. Each bit for "n" has the following meaning:

Bit	Position	Value	
		0	1
0	Paper Near-end 1	Disabled	Enabled
1	Paper Near-end 2	Disabled	Enabled
2	Paper-end	Disabled	Enabled
3	Paper-end	Disabled	Enabled
4	Undefined	---	---
5	Undefined	---	---
6	Undefined	---	---
7	Undefined	---	---

[Caution] This command is valid only for the parallel interface.

[Default] n=0

ESC c 4 n

[Function] Selecting the Paper Near-end Sensor valid for print stop

[Code] <1B>H<63>H<34>H<n>

[Range] $0 \leq n \leq 255$

[Outline] This command selects the Paper Near-end Sensor which helps to stop printing when the paper supply almost runs out.
Each bit for "n" has the following meaning:

Bit	Position	Value	
		0	1
0	Paper Near-end 1	Disabled	Enabled
1	Paper Near-end 2	Disabled	Enabled
2	Undefined	---	---
3	Undefined	---	---
4	Undefined	---	---
5	Undefined	---	---
6	Undefined	---	---
7	Undefined	---	---

[Caution] This printer can only select one kind of Paper Sensor, a Paper Near-end Sensor.

[Default] When memory switch 2-8 is OFF: n = 1
When memory switch 2-8 is ON: n = 0

2.2.8 Panel Switch Commands

ESC c 5 n

[Function] Enabling/disabling the panel switches

[Code] <1B>H<63>H<35>H<n>

[Range] $0 \leq n \leq 255$

[Outline] Enabling/disabling the FEED switch.

- "n" is valid only for the lowest bit (n0).
- Control by the lowest bit (n0) is shown as follows:

n0	Condition
0	FEED switch valid
1	FEED switch invalid

[Caution]

- When the FEED switch is disabled with this command, the paper cannot be fed by operating the FEED switch.
- While switch operation is waited at the execution of macro, the FEED switch is always enabled regardless of the setting of this command but no paper feed operation is carried out.

[Default] n=0

[Sample Program]

```
LPRINT CHR$(&H1B);"c5";CHR$(0); ..... When enabling the FEED switch  
LPRINT CHR$(&H1B);"c5";CHR$(1); ..... When disabling the FEED switch
```

2.2.9 Macro Commands

GS :

[Function] Starting/ending macro definition

[Code] <1D>H<3A>H

[Outline] Specifying starting/ending macro definition.
Reception of this command during macro definition signifies ending the macro definition.

[Caution]

- Maximum content available for macro definition is 2048 bytes. A portion exceeding 2048 bytes is not defined.
- When GS ^ is processed in macro definition, the macro definition is stopped and the content of definition is cleared.
- Even with ESC @ having been executed, defined content is not cleared. Therefore, it is possible to include ESC @ into the content of macro definition.
- Normal printing operation is carried out even during macro definition.

[Default] The initial value is not defined.

[See Also] [GS ^](#)

[Sample Program]

```
LPRINT CHR$(&H1D);":";
LPRINT "+-----+"; CHR$(&HA);
LPRINT "|      |"; CHR$(&HA);
LPRINT "+-----+"; CHR$(&HA);
LPRINT CHR$(&H1D);":";
LPRINT CHR$(&H1D);"^";
LPRINT CHR$(2); CHR$(10);
```

[Print Results]

```
+-----+
|      |
+-----+
+-----+
|      |
+-----+
+-----+
|      |
+-----+
```

↑
Printing during macro execution
↓

↑
Normal printing during macro definition
↓

GS ^ n1 n2 n3

[Function]	Executing the macro
[Code]	<1D>H<5E>H<n1><n2><n3>
[Range]	$0 \leq n1 \leq 255$ $0 \leq n2 \leq 255$ $0 \leq n3 \leq 1$
[Outline]	Executing contents defined in macro. n1 : The number of times of macro execution n2 : Waiting time on macro execution. Waiting time of $n2 \times 100$ msec is given for every execution. n3 : Macro execution mode n3 = 0 Continuous execution: The Macro is executed "n1" times continuously at the time interval specified by "n2". n3 = 1 Execution by FEED Switch: After waiting for the time specified by "n2", the ALARM LED flickers and the FEED switch is waiting to be pressed. When it is pressed, the macro is executed once. This action is repeated "n1" times.
[Caution]	<ul style="list-style-type: none">• When this command is received while in macro definition, suspension of macro definition is indicated. At this time, the defined content is cleared.• No execution takes place when the macro is held undefined.• While in macro execution with $n3 = 1$, paper feed with the FEED switch is not available.
[See Also]	GS :
[Sample Program]	Refer to Sample Program and Print Results for GS .:

2.2.10 Cutter Commands

ESC i

[Function] Full cutting of paper

[Code] <1B>H<69>H

[Outline] Executes full cutting of paper.

[Caution]

- This command only works if it is entered at the beginning of a line.
- Before cutting paper, feed the paper more than the cutting position of paper from the print position. Without this paper feeding, the character just after printing remains before the cutter.

[Sample Program]

```
LPRINT "AAAAA";  
LPRINT CHR$(&H1B);"J";  
LPRINT CHR$(150);  
LPRINT CHR$(&H1B);"i";
```

[Print Results]

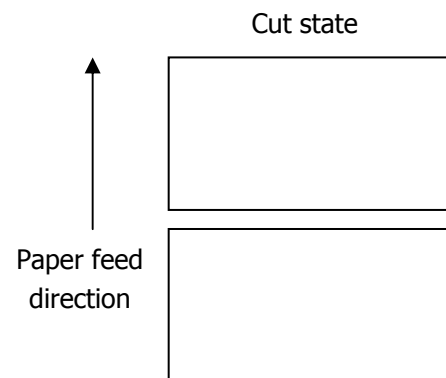
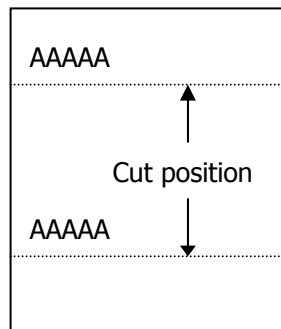

ESC m

[Function] Full cutting of paper

[Code] <1B>H<6D>H

[Outline] Executes full cutting of paper.

- [Caution]**
- This command only works if it is entered at the beginning of a line.
 - Before cutting paper, feed the paper more than the cutting position of paper from the print position. Without this paper feeding, the character just after printing remains before the cutter.

[Sample Program]

```
LPRINT "AAAAA";  
LPRINT CHR$(&H1B);"J";  
LPRINT CHR$(150);  
LPRINT CHR$(&H1B);"m";
```

[Print Results]

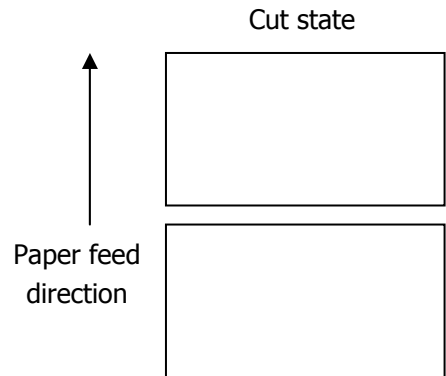
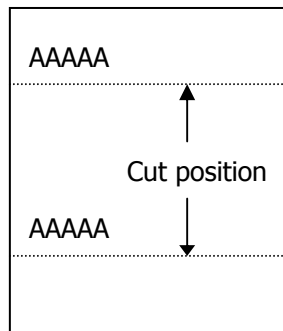

GS V m ... (1)

GS V m n ... (2)

[Function] Cutting the paper

[Code] (1)<1D>H<56>H<m>
(2)<1D>H<56>H<m><n>

[Range] (1) $0 \leq m \leq 1$, $48 \leq m \leq 49$
(2) $65 \leq m \leq 66$

[Outline] Performs the specified paper cutting.

m	Function
0,48	Full cut
1,49	Full cut
65	Paper feed by "cut position + basic calculation pitch" and full cut
66	Paper feed by "cut position + basic calculation pitch" and full cut

[Caution]

- In STANDARD MODE, this command only works when it is entered at the beginning of a line.
- Control to make the length of cut paper less than 10 mm is not executed.

For (1):

- Executes cutting of paper.

For (2):

- If $n = 0$, the paper is fed to the cut position, and then cut. If $n \neq 0$, the paper is fed by " $n \times$ basic calculation pitch" inches past the cut position, and then cut.
- The basic calculation pitch is set by GS P.
- The paper feed amount is calculated with the vertical basic calculation pitch (y). A fraction resulting from the calculation is corrected with the minimum pitch of the mechanism, and the remainder is omitted.

2.2.11 Bar Code Commands

GS H n

[Function] Selecting of printing position of HRI characters

[Code] <1D>H<48>H<n>

[Range] $0 \leq n \leq 3$, $48 \leq n \leq 51$

[Outline] Selecting printing position of HRI characters in printing bar codes.
"n" means the followings.

n	Printing Position
0,48	No printing
1,49	Above the bar code
2,50	Below the bar code
3,51	Both above and below the bar code

The HRI characters refer to the bar code-turned characters so that you can read them.

[Caution]

- The HRI characters are printed in the font selected with GS f.
- Specify before the GS k command.

[Default] n=0

[See Also] [GS f](#), [GS k](#)

[Sample Program]

```
LPRINT CHR$(&H1B);"3"; CHR$(5);
LPRINT CHR$(&H1D);"h"; CHR$(50);
LPRINT CHR$(&H1D);"H"; CHR$(0);
GOSUB BC
LPRINT CHR$(&H1D);"H"; CHR$(1);
GOSUB BC
LPRINT CHR$(&H1D);"H"; CHR$(2);
GOSUB BC
LPRINT CHR$(&H1D);"H"; CHR$(3);
GOSUB BC
END
BC:
LPRINT CHR$(&H1D);"k";
LPRINT CHR$(4);
LPRINT "12"; CHR$(0);
LPRINT CHR$(&HA);
RETURN
```

[Print Results]

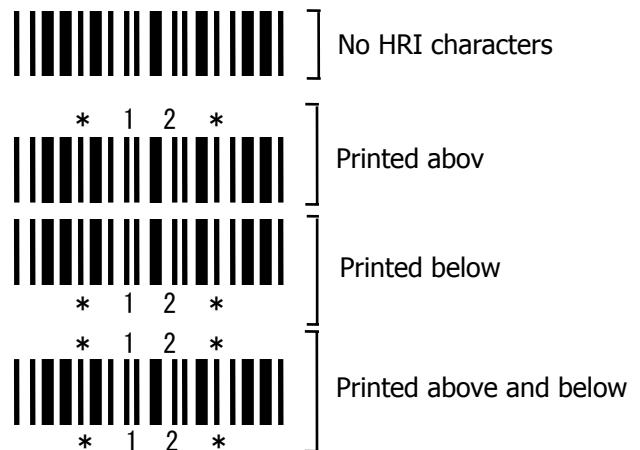

GS f n

[Function] Selecting the font of HRI characters

[Code] <1D>H<66>H<n>

[Range] $0 \leq n \leq 2$, $48 \leq n \leq 50$

[Outline] Selecting the font of HRI characters in printing bar code.
The type of font can be selected with "n" as follows:

n	Font
0,48	FontA(12×24)
1,49	FontB(9×24)
2,50	FontC(8×16)

The HRI characters refer to the bar code-turned characters so that you can read them.

[Caution] The HRI characters are printed at the position specified with GS H.

[Default] n=0

[See Also] [GS H](#)

[Sample Program]

```
LPRINT CHR$(&H1D);"h"; CHR$(50);
LPRINT CHR$(&H1D);"H"; CHR$(2);
LPRINT CHR$(&H1D);"f"; CHR$(0);
GOSUB BC
LPRINT CHR$(&H1D);"f"; CHR$(1);
GOSUB BC
END
BC:
LPRINT CHR$(&H1D);"k";
LPRINT CHR$(4);
LPRINT "12"; +CHR$(0);
LPRINT CHR$(&HA);
RETURN
```

[Print Results]

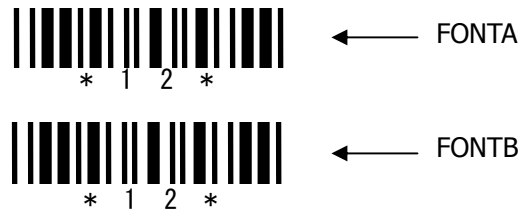

GS h n

- [Function]** Specifying the height of the bar code
- [Code]** <1D>H<68>H<n>
- [Range]** $1 \leq n \leq 255$
- [Outline]** Selecting bar code height.
"n" denotes the number of dots in the vertical direction.
- [Default]** n=162
- [See Also]** [GS k](#), [GS w](#)
- [Sample Program]**
[Refer to Sample Program and Print Results for GS w.](#)

GS k m [d1...dk] NULL ... (1)

GS k m n [d1...dn] ... (2)

[Function] Printing the bar code

[Code] (1)<1D>H<6B>H<m>[d1...dk] NULL
 (2)<1D>H<6B>H<m><n>[d1...dn]

[Range] (1) $0 \leq m \leq 6$ The definitions of "k" and "d" vary with the bar code system.
 (2) $65 \leq m \leq 73$ The definitions of "n" and "d" vary with the bar code system.

[Outline] Selects a bar code system and prints the bar code.
 The type of font can be selected with "n" as follows.

For (1):

m	Bar Code System	Range of "k"	Range of "d"
0	UPC-A	$11 \leq k \leq 12$	$48 \leq d \leq 57$
1	UPC-E	$11 \leq k \leq 12$	$48 \leq d \leq 57$
2	JAN13(EAN)	$12 \leq k \leq 13$	$48 \leq d \leq 57$
3	JAN8(EAN)	$7 \leq k \leq 8$	$48 \leq d \leq 57$
4	CODE39	$1 \leq k$	$48 \leq d \leq 57, 65 \leq d \leq 90$ 32, 36, 37, 43, 45, 46, 47
5	ITF	$1 \leq k$ (An even number)	$48 \leq d \leq 57$
6	CODABAR	$1 \leq k$	$48 \leq d \leq 57, 65 \leq d \leq 68$ 36, 43, 45, 46, 47, 58

For (2):

m	Bar Code System	Range of "n"	Range of "d"
65	UPC-A	$11 \leq n \leq 12$	$48 \leq d \leq 57$
66	UPC-E	$11 \leq n \leq 12$	$48 \leq d \leq 57$
67	JAN13(EAN)	$12 \leq n \leq 13$	$48 \leq d \leq 57$
68	JAN8(EAN)	$7 \leq n \leq 8$	$48 \leq d \leq 57$
69	CODE39	$1 \leq n \leq 255$	$48 \leq d \leq 57, 65 \leq d \leq 90$ 32, 36, 42, 43, 45, 46, 47
70	ITF	$1 \leq n \leq 255$ (An even number)	$48 \leq d \leq 57$
71	CODABAR	$1 \leq n \leq 255$	$48 \leq d \leq 57, 65 \leq d \leq 68$ 36, 43, 45, 46, 47, 58
72	CODE93	$1 \leq n \leq 255$	$0 \leq d \leq 127$
73	CODE128	$2 \leq n \leq 255$	$0 \leq d \leq 127$

[Caution]

For (1):

- This command ends with a NULL code.
- For UPC-A or UPC-E, the bar code is printed when 12 bytes of bar code data have been entered, and the subsequent data is handled as normal data.
- For JAN13, the bar code is printed when 13 bytes of bar code data have been entered, and the subsequent data is handled as normal data.
- For JAN8, the bar code is printed when 8 bytes of bar code data have been entered, and the subsequent data is handled as normal data.
- The data of ITF bar code must have an even number of columns. Should the data have an odd number of columns, the last column is ignored.

For (2):

- Numeral "n" indicates the number of data items, and the subsequent "n" bytes of data are handled as bar code data.
- If "n" is out of the range, the processing of the command is aborted, and the subsequent data is handled as normal data.

For STANDARD MODE:

- If "d" is out of the range, only a paper feed is executed, and the subsequent data is handled as normal data.
- If the bar code is wider than the print area for one line, the bar code is not printed, but only a paper feed is executed.
- The amount of paper feed corresponds to the height of the bar code (including the HRI characters if HRI character printing is specified), irrespective of the line feed width set by a command such as ESC 2 or ESC 3.
- This command only works if no data exists in the print buffer. If any data exists in the print buffer, the data subsequent to "m" is handled as normal data.
- After the bar code is printed, the beginning of the line is taken as the start position for the next print.
- This command is not affected by any print modes (emphasis, double strike, underline, and character size), except for the inverted character mode.

For PAGE MODE:

- This command only maps the bar code, without performing a printout. After the bar code is mapped, the dot next to the last data item of the bar code is taken as the start position for the next data mapping.
- If "d" is out of the range, the processing of the command is aborted, and the subsequent data is handled as normal data. In this case, the data mapping start position does not move.
- If the bar code is wider than the print area, the bar code is not printed, but the data mapping start position is moved to the left end of the non-print area.

[Description of Bar Codes]

UPC-A	This bar code, consisting of numerals only, has a fixed length of 12 columns; a 11-column number entered from the host or application software plus a check digit (12th column) automatically calculated inside the printer. If the 12th-column numeral is sent from the host, the entire bar code will be printed as it is.
UPC-E	This bar code, consisting of numerals only, has a fixed length of 8 columns; the first number system character is "0" stationary. A 12-column numeral entered from the host or application software is compressed to 8 columns with a check digit attached and then is printed. The 12th-column check digit is automatically calculated inside the printer. If it is and sent from the host, the entire bar code will be printed, compressed to 8 columns.
JAN-13(EAN)	This bar code, consisting of numerals only, has a fixed length of 13 columns; a 12-column number entered from the host or application software plus a check digit (13th column) automatically calculated inside the printer. If the 13th-column numeral is sent from the host, the entire bar code will be printed as it is.
JAN-8(EAN)	This bar code, consisting of numerals only, has a fixed length of 8 columns; a 7- column number entered from the host or application software plus a check digit (8th column) automatically calculated inside the printer. If the 8th-column numeral is sent from the host, the entire bar code will be printed as it is.
CODE39	This bar code, consisting of upper-case alphabetic characters and numerals, has a variable length of columns. The start/stop code "*" is automatically added by the printer. The available characters include space and "\$ % * + - . / 0 1 2 3 4 5 6 7 8 9" and upper-case alphabetic characters.
ITF	This bar code, consisting of only numerals, has a variable length of even-number columns. If a code of odd-number columns is sent, the bar code will not be printed.
CODABAR(NW-7)	This bar code, consisting of alphanumerics, has a variable length of columns. Available characters include "0 1 2 3 4 5 6 7 8 9 \$ + - . / :". A start/stop code is required; any one of A, B, C, and D is used.
CODE93	This bar code, consisting of alphanumeric and control characters, has a variable length of columns. The HRI character string is preceded and followed by a "_" character. HRI characters for control characters (00H - 1FH, and 7FH) are each printed as a combination of a "_" character and an alphabetic character.

Control Character		HRI Character	Control Character		HRI Character
ASCII	Hex.		ASCII	Hex.	
NULL	00	■U	DLE	10	■P
SOH	01	■A	DC1	11	■Q
STX	02	■B	DC2	12	■R
ETX	03	■C	DC3	13	■S
EOT	04	■D	DC4	14	■T
ENQ	05	■E	NAK	15	■U
ACK	06	■F	SYN	16	■V
BEL	07	■G	ETB	17	■W
BS	08	■H	CAN	18	■X
HT	09	■I	EM	19	■Y
LF	0A	■J	SUB	1A	■Z
VT	0B	■K	ESC	1B	■A
FF	0C	■L	FS	1C	■B
CR	0D	■M	GS	1D	■C
SO	0E	■N	RS	1E	■D
SI	0F	■O	US	1F	■E
			DEL	7F	■T

CODE128

This bar code consists of 103 bar code characters and three code sets, enabling 128 ASCII code characters to be printed. It has a variable length of columns.

- Code set A ASCII characters 00H - 5FH can be represented.
- Code set B ASCII characters 20H - 7FH can be represented.
- Code set C Two-digit numbers 00 - 99 can each be represented by one character. In addition to the above characters, special characters are available:
- Shift character (SHIFT)
 - When used in code set A, one character next to a Shift character is treated as a character of code set B.
 - When used in code set B, one character next to a Shift character is treated as a character of code set A.
 - The Shift character cannot be used in code set C.
- Code set select characters (CODE A, CODE B, CODE C):
 - The code set following a code set select character is switched to code set A, B, or C.
- Function characters (FNC1, FNC2, FNC3, FNC4):
 - How the function characters are used depends on each application. In code set C, only FNC1 is available.
- When sending print data, note these points:
 - (1) Each string of bar code data must begin with a code set select character (CODE A, CODE B, or CODE C), which selects the first code set to use.
 - (2) Every special character is specified by a combination of two characters: a brace "{" followed by one character. A brace "{" itself is sent twice consecutively.

Special characters

Hex.	ASCII	Code Set A	Code Set B	Code Set C
7B53	{S	SHIFT	SHIFT	-N/A
7B41	{A	-N/A	CODE A	CODE A
7B42	{B	CODE B	-N/A	CODE B
7B43	{C	CODE C	CODE C	-N/A
7B31	{1	FNC1	FNC1	FNC1
7B32	{2	FNC2	FNC2	-N/A
7B33	{3	FNC3	FNC3	-N/A
7B34	{4	FNC4	FNC4	-N/A
7B7B	{{	{ }	{ }	{ }

<Example> To print "No." in code set B, followed by "123456" in code set C, send the following data string:

GS k <73> <10> <7B>H <42>H, " No." <7B>H <43>H <12> <34> <56>

- If the printer finds a string of bar code data that does not begin with a code set select character, it immediately aborts the command processing and handles the subsequent data as normal data.
- If the printer received a character that is not available in the currently selected code set, it immediately aborts the command processing and handles the subsequent data as normal data.
- An HRI character corresponding to either a Shift character or a code select character is not printed. An HRI character for either a function character or a control character is treated as a space character.

[Sample Program]

```
LPRINT CHR$(&H1D);"H"; CHR$(2);
LPRINT CHR$(&H1D);"k";
LPRINT CHR$(4);
LPRINT "123"; CHR$(0);
```



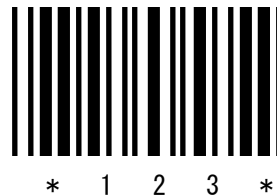





[Print Results]



When the data "123" is printed with the CODE 39.

[Bar Code Print Example]

UPC-A, UPC-E, JAN-13 (EAN), JAN-8 (EAN), CODE 39, ITF, CODABAR, CODE 93, CODE 128

Type	Print Sample	Outline of Symbol
UPC-A		12-column fixed-length bar code consisting of numerals only.
UPC-E		8-column fixed-length bar code consisting of numerals only. Abbreviated version of UPC-A.
JAN13		13-column fixed-length bar code consisting of numerals only.
JAN8		8-column fixed-length bar code consisting of numerals only.
CODE39		Variable-length bar code consisting of alphabetic characters and numerals. The start/stop code "*" is automatically added.
ITF		Even-column variable-length bar code consisting of numerals only.
CODABAR (NW-7)		Variable-length bar code consisting of alphanumeric characters. Any one of A, B, C, and D is required as the start/ stop code.
CODE93		Variable-length bar code consisting of alphanumeric and control characters.
CODE128		Variable-length bar code consisting of any of 128 ASCII code characters.

Printing is done according to bar code type, number of print columns, bar code height, width (magnification), availability of HRI character, and bar code data.

GS w n

[Function] Specifying the horizontal size (magnification) of bar code

[Code] <1D>H<77>H<n>

[Range] $2 \leq n \leq 6$

[Outline] Selecting bar code width.

[Default] $n=3$

[Sample Program]

```
LPRINT CHR$(&H1D);"h"; CHR$(30);
LPRINT CHR$(&H1D);"w"; CHR$(2);
GOSUB BC
LPRINT CHR$(&H1D);"h"; CHR$(50);
LPRINT CHR$(&H1D);"w"; CHR$(3);
GOSUB BC
LPRINT CHR$(&H1D);"h"; CHR$(80);
LPRINT CHR$(&H1D);"w"; CHR$(4);
GOSUB BC
END
BC:
LPRINT CHR$(&H1D);"k";
LPRINT CHR$(4);
LPRINT "12"; CHR$(0);
RETURN
```

[Print Results]



Height = 30, Magnification = 2

Height = 50, Magnification = 3

Height = 80, Magnification = 4

2.2.12 Commands for Non-volatile Memory

GS (C pL pH m fn b [c1 c2] [d1...dk]

[Function] Editing user NV memory

- [Outline]**
- Erases/stores/sends data of user NV memory area and sends the use amount/remaining capacity.
 - Executes edit processing of user NV memory specified by function code (fn).

fn	Code	No.	Function.
0,48	GS (C pL pH m fn b c1 c2	Function 0	Erases specified record.
1,49	GS (C pL pH m fn b c1 c2 d1...dk	Function 1	Stores data in specified record.
2,50	GS (C pL pH m fn b c1 c2	Function 2	Sends data stored in specified record.
3,51	GS (C pL pH m fn b	Function 3	Sends capacity of use (number of bytes).
4,52	GS (C pL pH m fn b	Function 4	Sends remaining capacity (number of bytes).
5,53	GS (C pL pH m fn b	Function 5	Sends key code list of stored record.
6,54	GS (C pL pH m fn b d1 d2 d3	Function 6	Erases all areas of user NV memory in a lump.

- pL, PH specifies the number of bytes of "m" and the following to (pL+pH×256).
- c1, c2 specifies key code (ID code of record).
- Total capacity of user NV memory can be specified as any of [1K, 64K, 128K, 192K] bytes by GS (E. Default value is 1K byte.

- [Caution]**
- Frequent use of this command may result in damage of NV memory. Use the Write command to NV memory in consideration of [10 times max./day].
 - Following the processing of this command, printer Busy may occur during writing data in NV memory. While the printer is Busy, it stops receiving process. Therefore, data transmission (including real-time command) from host is prohibited.

fn = 0, 48: Function 0 Erasing Specified Record

GS (C pL pH m fn b c1 c2

[Code] <1D>H<28>H<43>H<pL><pH><m><fn>[c1 c2]

[Range] $(pL + pH \times 256) = 5$ ($pL = 5, pH = 0$)
 $m = 0$
 $fn = 0, 48$
 $b = 0$
 $32 \leq c1 \leq 126$
 $32 \leq c2 \leq 126$

[Outline] Erases the record specified by c1, c2 stored in user NV memory.

fn = 1, 49: Function 1 Storing Data to Specified Record

GS (C pL pH m fn b c1 c2 d1...dk

[Code] <1D>H<28>H<43>H<pL><pH><m><fn>[c1 c2][d1...dk]

[Range] $6 \leq (pL + pH \times 256) \leq 65535$ ($0 \leq pL \leq 255, 0 \leq pH \leq 255$)
 $m = 0$
 $fn = 1, 49$
 $b = 0$
 $32 \leq c1 \leq 126$
 $32 \leq c2 \leq 126$
 $32 \leq d \leq 254$
 $k = (pL + pH \times 256) - 5$

[Outline]

- Stores data to the record specified by c1, c2.
- When the data is present in NV memory, it is replaced by new data.

fn = 2, 50: Function 2 Sending Data Stored in Specified Record

GS (C pL pH m fn b c1 c2

[Code] <1D>H<28>H<43>H<pL><pH><m><fn>[c1 c2]

[Range] (pL+pH×256)=5(pL=5, pH=0)
 m=0
 fn=2, 50
 b=0
 32≤c1≤126
 32≤c2≤126

[Outline] Sends data stored in the record specified by c1, c2 in user NV memory.

	Hex.	Decimal	Data Size
Header	37H	55	1 byte
Identifier	70H	112	1 byte
Status	40H or 41H	64 or 65	0~80 bytes
Data	20H~FEH	32~254	1 byte
NUL	00H	0	1 byte

Transmission data in case specified record cannot be detected is as shown below.

	Hex.	Decimal	Data Size
Header	37H	55	1 byte
Identifier	70H	112	1 byte
Status	40H	64	1 byte
NUL	00H	0	1 byte

After sending [Header - NUL], a response is received from host and next processing corresponding to the response is executed.

- In case of "Status (with continuous block): hexadecimal number = 41H / decimal number = 65"

Response		Content of Processing
ASCII	Decimal	
ACK	6	Sends next data group.
NAK	21	Resends previous data group.
CAN	24	Cancels processing.

- In case of "Status (last block): hexadecimal number = 40H / decimal number = 64"

Response		Content of Processing
ASCII	Decimal	
ACK	6	Terminates processing.
NAK	21	Resends previous data group.
CAN	24	Cancels processing.

fn = 3, 51: Function 3 Sending Use Amount

GS (C pL pH m fn b

[Code] <1D>H<28>H<43>H<pL><pH><m><fn>

[Range] $(pL + pH \times 256) = 3$ (pL=3, pH=0)
m=0
fn=3, 51
b=0

[Outline] Sends the use amount of user NV memory (number of bytes of used area).

	Hex.	Decimal	Data Size
Header	37H	55	1 byte
Identifier	28H	40	1 byte
Capacity of use	30H~39H	48~57	1~6 bytes
NUL	00H	0	1 byte

fn = 4, 52: Function 4 Sending Remaining Capacity

GS (C pL pH m fn b

[Code] <1D>H<28>H<43>H<pL><pH><m><fn>

[Range] $(pL + pH \times 256) = 3$ (pL=3, pH=0)
m=0
fn=4, 52
b=0

[Outline] Sends the remaining capacity of user NV memory (number of bytes of unused area).

	Hex.	Decimal	Data Size
Header	37H	55	1 byte
Identifier	29H	41	1 byte
Capacity of use	30H~39H	48~57	1~6 bytes
NUL	00H	0	1 byte

fn = 5, 53: Function 5 Sending Key Code List of Stored Record

GS (C pL pH m fn b

[Code] <1D>H<28>H<43>H<pL><pH><m><fn>

[Range] (pL + pH×256) = 3 (pL=3, pH=0)
 m=0
 fn=5, 53
 b=0

[Outline] Sends key code list of record existing in user NV memory.

	Hex.	Decimal	Data size
Header	37H	55	1 byte
Identifier	71H	113	1 byte
Status	40H or 41H	64 or 65	1 byte
Data	20H~FEH	32~254	2~80 bytes
NUL	00H	0	1 byte

- Data is a data group with a list of key codes.

Transmission data group when record is not detected is as shown below.

	Hex.	Decimal	Data Size
Header	37H	55	1 byte
Identifier	71H	113	1 byte
Status	40H	64	1 byte
NUL	00H	0	1 byte

After sending [Header - NUL], receives a response from the host and executes the next processing corresponding to the response.

- In case of "Status (with continuous block): hexadecimal number = 41H / decimal number = 65"

Response		Content of Processing
ASCII	Decimal	
ACK	6	Sends next data group.
NAK	21	Resends previous data group.
CAN	24	Cancels processing.

- In case of "Status (last block): hexadecimal number = 40H / decimal number = 64"

Response		Content of Processing
ASCII I	Decimal	
ACK	6	Terminates processing.
NAK	21	Resends previous data group.
CAN	24	Cancels processing.

fn = 6, 54: Function 6 Erasing All User NV Memory Area in a Lump

GS (C pL pH m fn b [d1 d2 d3]

[Code] <1D>H<28>H<43>H<pL><pH><m><fn>[d1 d2 d3]

[Range] (pL+pH×256)=6 (pL=6, pH=0)
m=0
fn=6, 54
b=0
d1=67
d2=76
d3=82

[Outline] Erases all areas of user NV memory in a lump.

FS p n m

[Function] Printing the download NV bit images

[Code] <1C>H<70>H<n><m>

[Range] $1 \leq n \leq 255$, $0 \leq m \leq 3$, $48 \leq m \leq 51$

[Outline] This command prints the download NV bit images (n) using a specified mode (m).

m	Mode Name	Dot Density in Vertical Direction	Dot Density in Horizontal Direction
0,48	NORMAL MODE	203DPI	203DPI
1,49	DOUBLE WIDTH MODE	203DPI	101DPI
2,50	DOUBLE HEIGHT MODE	101DPI	203DPI
3,51	QUADRUPLE SIZE MODE	101DPI	101DPI

- "n" denotes the number of the download bit image.
- "m" denotes the bit image mode.

- [Caution]**
- The download NV bit image refers to the image that is defined by the FS q command in the non-volatile memory and printed by the FS p command.
 - When the specified NV bit image "n" is undefined, this command is invalid.
 - When the STANDARD MODE is selected, this command is valid only when there is no data in the print buffer.
 - This command is invalid when PAGE MODE is selected.
 - Any printing modes except the upside-down printing mode (i.e. emphasis, double strike, underlining, character size, inverted character printing, 90°-right-turned) are not affected.
 - When the printing area set by the functions GS L and GS W is not enough for one vertical line of the download NV bit image, the line alone is dealt with as follows. One vertical line of the bit image is 1 dot in NORMAL MODE (m = 0, 48) and DOUBLE HEIGHT MODE (m = 2, 50), and it is 2 dots in double WIDTH MODE (m = 1, 49) and QUADRUPLE SIZE MODE (m = 3, 51).
 - (1) The printing area is extended to the right side within the limits of the printing area so that one vertical line of the download NV bit image can be printed.
 - (2) When a sufficient printing area cannot be maintained even after executing (1), the printing area is extended to the left side. (The left margin is reduced.)
 - When the size of a bit image exceeds the limits of the printing area, the data within the limits of the printing area will be printed but the parts exceeding the limit will not be printed.
 - Regardless of the amount of line feed set with ESC 2 and ESC 3, NORMAL MODE and DOUBLE WIDTH MODE execute a paper feed of (height "n" of NV bit image) dots while DOUBLE HEIGHT MODE and QUADRUPLE SIZE MODE execute a paper feed of (height "n" of NV bit image×2) dots.
 - At the completion of the bit image printing, the head of the line will be used for the next printing position and normal data processing will take place.

[See Also] [ESC *](#), [FS q](#), [GS /](#), [GS v 0](#)

FS q n [xL xH yL yH d1...dk]1 ... [xL xH yL yH d1...dk]n

[Function] Defining the download NV bit image

[Code] <1C>H<71>H<n>[<xL><xH><yL><yH><d1...dk>]1 ... [<xL><xH><yL><yH><d1...dk>]n

[Range] $1 \leq n \leq 255$
 $0 \leq xL \leq 255$
 $0 \leq xH \leq 3$ but, $1 \leq (xL + xH \times 256) \leq 1023$
 $0 \leq yL \leq 255$
 $0 \leq yH \leq 1$ but, $1 \leq (yL + yH \times 256) \leq 288$
 $0 \leq d \leq 255$
 $k = (xL + xH \times 256) \times (yL + yH \times 256) \times 8$
Total definition area = 2M bits (256K bytes)

[Outline] This command defines the specified NV bit image.

- "n" denotes the number of bit images to be defined.
- xL and xH denote the horizontal size of one NV bit image as $(xL + xH \times 256) \times 8$ dots.
- yL and yH denote the vertical size of one NV bit image as $(yL + yH \times 256) \times 8$ dots.

[Caution]

- Because all the NV bit images previously defined by this command are deleted, it is not possible to redefine any one of the previously defined multiple data. All the data must be resent.
- From the execution of this command until the completion of the hardware reset, any mechanical operation such as opening the cover, initializing the printer head position, or using the paper-feed switch etc.
- The NV bit image refers to a bit image that is defined by the FS q command in the non-volatile memory and printed by the FS p command.
- When the STANDARD MODE is selected, this command is only valid when it is written at the head of a line.
- This command is invalid when PAGE MODE is selected.
- This command becomes valid after the 7 bytes of <FS q n xL xH yL yH> are processed as normal values.
- When data which exceeds the remaining capacity of the defined area is specified by xL, xH, yL, yH, outside-defined-area arguments will be processed.
- When outside-defined-area arguments are processed for the first bit image data group, this command becomes invalid.
- If outside-defined-area arguments are processed for the second or subsequent NV bit image data groups, the processing of this command is suspended, and a writing process into the non-volatile memory starts. At this time, the NV bit image being defined becomes invalid (Undefined), but the preceding NV bit images are valid.
- "d" denotes the definition data. Bits which correspond to dots to be printed are represented as "1", and those not to be printed as "0".

- The definition will start from NV bit image number 01H and n-number bit images will be defined in ascending order. Therefore, the first data group [xL xH yL yH d1...dk] becomes NV bit image number 01H, and the last data group [xL xH yL yH d1...dk] becomes NV bit image number 0nH. These numbers of NV bit images coincide with those specified with FS p.
- The definition data of one NV bit image consists of [xL xH yL yH d1... dk]. Therefore, when only one NV bit image is defined, n = 1; the data group [xL xH yL yH d1...dk] is manipulated once, and [Data: ((xL+xH×256)×(yL+yH×256)×8)+Header: (4)] bytes of non-volatile memory is used to store it.
- The maximum definition area of this printer is 2M bits (256K bytes). Multiple NV bit images can be defined, but bit images of which total size (Bit image data + Header) exceeds 2M bits (256K bytes) can not be defined.
- The printer state will change to BUSY just before the writing operation into the non-volatile memory begins. Also, for a printer that have a dip switch [BUSY], the printer state will change to BUSY just before the writing operation begins regardless of the state of the dip switch.
- While this command is being executed, it is not possible to send ASB status or to detect the printer status even when the ASB function is selected.
- If this command is sent while a macro is still being defined, the definition process will be stopped and the execution of this command will start.
- NV bit images that are defined already are not initialized by using ESC @ command, or by resetting the printer or turning the power off.
- The command only executes definition of NV bit image, but not starts printing. The printing of NV bit image will be executed by FS p.
- Because frequent writing in the non-volatile memory can destroy the memory, the writing command should be used less than 10 times a day.
- Just after the completion of the writing operation into the non-volatile memory, the printer hardware will be reset. Therefore, download characters, download bit images, and macro definition will be made undefined. The receiving buffer/printer buffer will be cleared, and each setting will go back to its default value. Then the status of dip switches will be checked once more.
- It may happen that the printer becomes BUSY during the process of writing data into the non-volatile memory in the execution of this command. When the printer becomes BUSY, it will stop receiving data. Therefore, sending data from the host (including real time command) is prohibited.

[See Also] [FS p](#)

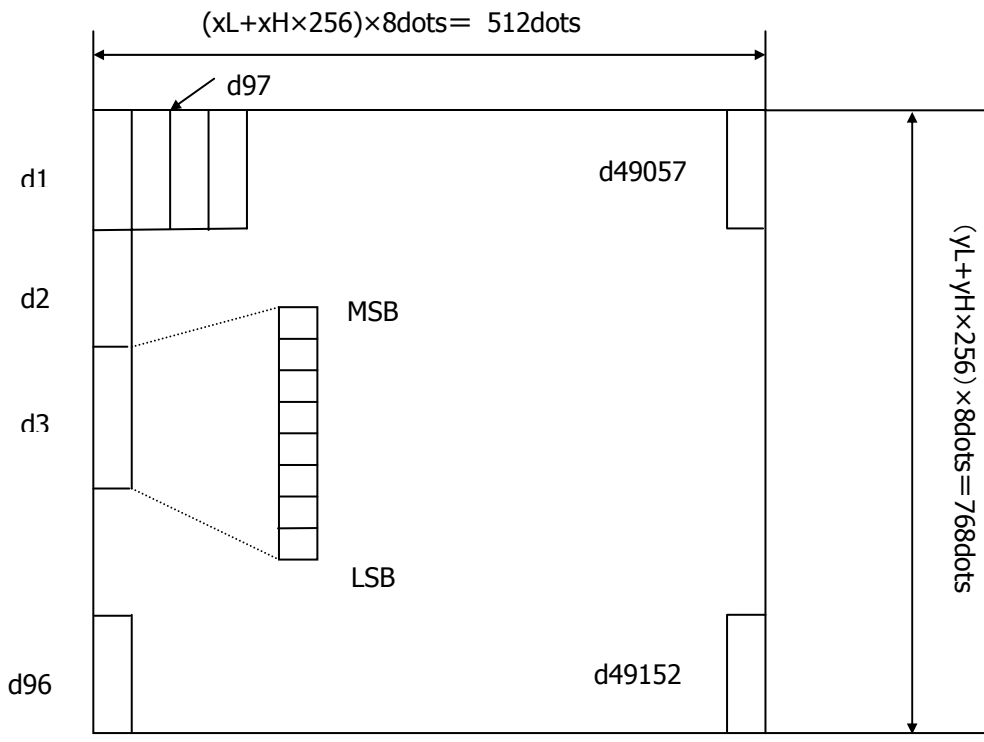

[Example] When $xL = 64$, $xH = 0$, $yL = 96$, $yH = 0$

2.2.13 Printer Function Setting Commands

GS (E pL pH fn [···])

[Function] Printer function setting command

[Outline] Printer function setting command is a command to change the function of the printer stored on the non-volatile memory and executes the function set by the value of "fn".

Function No.	Function
Function 1	Transfers to printer function setting mode.
Function 2	Terminates printer function setting mode.
Function 3	Sets memory switch value.
Function 4	Sends memory switch value set.
Function 5	Sets customize value.
Function 6	Sends customized value set.
Function 7	Copies user-defined page.
Function 8	Defines the data in column format to the character code page of work area.
Function 9	Defines the data in raster format to the character code page of work area.
Function 10	Erases the data of character code page of work area.
Function 11	Sets the communication condition of serial interface.
Function 12	Sends the communication condition of serial interface set.
Function 48	Erasing paper layout.
Function 49	Setting paper layout.
Function 50	Sending paper layout information.
Function 255	Sets all contents set in printer function setting mode to the state at the time of shipment.

- pL, pH set the number of bytes following "fn" to (pL+pH×256).
- At the end of printer function setting mode (Function 2), resetting is executed. Then the input buffer is cleared to return various kinds of setting to the state at the time of power on.
- The set value can be confirmed without transferring to printer function setting mode by functions 4, 6, and 12.
- Other functions do not operate without transferring to printer function setting mode.

[Caution]

- This command allows writing to non-volatile memory. Therefore, using this command frequently may result in breakage of memory. Use this command appropriately [10 times max./day].
- During execution of this command, the printer is in Busy state and stops receiving operation. Therefore, data transmission from the host is prohibited.

fn = 1: Function 1 Transferring to Printer Function Setting Mode

GS (E pL pH fn d1 d2

[Code] <1D>H<28>H<45>H<pL><pH><fn><d1><d2>

[Range] (pL+pH×256)=3 (pL=3, pH=0)
fn=1
d1=73("I")
d2=78("N")

[Outline] Transfers to printer function setting mode and sends the report of mode transfer.

	Hex.	No. of Data
Header	37H	1
ID	20H	1
NULL	00H	1

fn = 2: Function 2 End of Printer Function Setting Mode

GS (E pL pH fn d1 d2 d3

[Code] <1D>H<28>H<45>H<pL><pH><fn><d1><d2><d3>

[Range] (pL+pH×256)=4 (pL=4, pH=0)
fn=2
d1=79("O")
d2=85("U")
d3=84("T")

[Outline]

- Terminates printer function setting mode and executes resetting.
- Clears input buffer and print buffer and restores various kinds of setting to the state at power on.
- Operates only in printer function setting mode.

fn = 3: Function 3 Setting Memory Switch Value

GS (E pL pH fn [a1 b18...b11] ... [ak bk8...bk1]

[Code] <1D>H<28>H<45>H<pL><pH><fn>[a1 b18...b11] ... [ak bk8...bk1]

[Range] $10 \leq (pL + pH \times 256) \leq 65535$
 $fn = 3$
 $a = 1, 2, 3, 4$
 $b = 48, 49, 50$

[Outline] • Changes the memory switch set in "a" to the value set in "b".

b	Function
48	Sets corresponding bit to OFF.
49	Sets corresponding bit to ON.
50	Does not change corresponding bit.

• Setting memory switch 1 (a = 1)

Bit	b (Set Value)	Function
1	48 (Default)	Reports the power on.
	49	Does not report power on.
2	48 (Default)	Sets input buffer capacity to 4K bytes.
	49	Sets input buffer capacity to 45 bytes.
3	48 (Default)	Sets input buffer full and offline to be Busy.
	49	Sets to be busy with input buffer full.
4	48 (Default)	At the occurrence of receiving error, replaces the data with "?".
	49	At the occurrence of receiving error, ignores the data.
5	48 (Default)	Disables CR (ODH).
	49	Enables CR (ODH).
6	48 (Default)	Reserved
7	48 (Default)	Does not reset at serial I/F pin 6.
	49	Resets at serial I/F pin 6.
8	48 (Default)	Does not reset at serial I/F pin 25.
	49	Resets sat serial I/F pin 25.

• Setting memory switch 2 (a = 2)

Bit	b (Set Value)	Function
1	49 (Default)	Reserved
2	48	Disables auto cutter.
	49 (Default)	Enables auto cutter.
3	48	Enables stored printing.
	49 (Default)	Disables stored printing.
4	48	Sets printing at full columns to be the same as CBM1000.
	49 (Default)	Sets printing at full columns to be the same as EPSON.
5	48 (Default)	After cover close and PE recovery, prints as it is.
	49	After cover close and PE recovery, prints from the beginning using PAGE MODE, barcode, image, double-height printing, etc. as a unit.
6	48 (Default)	Reserved
7	48 (Default)	Reserved
8	48 (Default)	Enables PNE.
	49	Disables PNE.

• Setting memory switch 3 (a = 3)

Bit	b (Set Value)	Function
1	48 (Default)	After clearing cutter error, can be restored by Feed SW.
	49	After clearing cutter error, cannot be restored by Feed SW.
2	48 (Default)	When selecting cover open error as recoverable error, recovered by cover close.
	49	When selecting cover open error as recoverable error, recovered by command.
3	48 (Default)	Resets with parallel pin 31.
	49	Does not reset with parallel pin 31.
4	48 (Default)	Uses thermal paper.
	49	Uses Black mark paper.
5	48 (Default)	Reserved
6	48 (Default)	Reserved
7	48 (Default)	Sets PPU compatible mode.
	49	Sets L90 compatible mode.
8	48 (Default)	Sets cover open error during printing to be auto recovery
	49	Sets cover open error during printing to be recoverable error.

- Setting memory switch 4 (a = 4)

Bit	b (Set Value)	Function
1	48 (Default)	Undefined
2	48 (Default)	Undefined
3	48 (Default)	Executes initialization at power on.
	49	Does not execute initialization at power on.
4	48 (Default)	Does not perform collecting operation.
	49	Performs collecting operation.
5	48 (Default)	Backward collection
	49	Forward eject
6	48 (Default)	Normal eject
	49	Direct eject
7	48 (Default)	Next operation disabled with paper in presenter.
	49	Next operation enabled with paper in presenter.
8	48 (Default)	Undefined

* Bit 5 of memory switch 4 is valid when memory switch 4-4 is ON.

* Bit 7 of memory switch 4 is valid when memory switch 4-4 is OFF.

fn = 4: Function 4 Sending the Set Memory Switch Value

GS (E pL pH fn a

[Code] <1D>H<28>H<45>H<pL><pH><fn><a>

[Range] (pL+pH×256)=2
fn=4
a=1、2、3、4

[Outline] • Sends the content of memory switch set in "a".

	Hex.	No. of Data
Header	37H	1
ID	21H	1
Data	30H or 31H	8
NULL	00H	1

- Sends the set value of data in 8-byte data raw in order of bits 8, 7, 6,
OFF :30H("0")
ON :31H("1")

fn = 5: Function 5 Setting Customized Value

GS (E pL pH fn [a1 n1L n1H] ... [ak nkL nkH]

[Code] <1D>H<28>H<45>H<pL><pH><fn>[a1 n1L n1H] ... [ak nkL nkH]

[Range] $4 \leq (pL + pH \times 256) \leq 65535$
 $fn = 5$
 $a = 1, 2, 5, 6, 97, 116, 117$
 $1 \leq (nL + nH \times 256) \leq 65535$

[Outline] • Sets the customized value set in "a" to $(nL + nH \times 256)$.

a	Function
1	Specifies user NV memory capacity.
2	Specifies the memory capacity of NV graphics.
5	Selects printing density.
6	Selects printing speed.
97	Selects the number of divisions for conducting head.
116	Selects printing color.
117	Selects paper width.

• a = 1: Sets the user NV memory capacity to the size specified by $(nL + nH \times 256)$.

$(nL + nH \times 256)$	Memory Capacity
1 (Default)	1K bytes
2	64K bytes
3	128K bytes
4	192K bytes

• a = 2: Sets NV graphic memory capacity to the size specified by $(nL + nH \times 256)$.

$(nL + nH \times 256)$	Memory Capacity
1	None
2	64K bytes
3	128K bytes
4	192K bytes
5	256K bytes
6	320K bytes
7 (Default)	384K bytes

- a = 5: Sets printing density to the level specified by (nL+nH×256).

(nL+nH×256)	Printing Density
65530	70%
65531	75%
65532	80%
65533	85%
65534	90%
65535	95%
0 (Default)	100%
1	105%
2	110%
3	115%
4	120%
5	125%
6	130%
7	135%
8	140%

- a = 6: Sets printing speed to the value specified by (nL+nH×256).

(nL+nH×256)	Printing Speed
1	Printing speed level 1 (84%)
2	Printing speed level 2 (86%)
3	Printing speed level 3 (88%)
4	Printing speed level 4 (90%)
5	Printing speed level 5 (92%)
6	Printing speed level 6 (94%)
7	Printing speed level 7 (96%)
8	Printing speed level 8 (98%)
9 (Default)	Printing speed level 9 (100%)

- a = 97: Sets the number of divisions for conducting head specified by (nL+nH×256).

(nL+nH×256)	No. of Divisions for Conducting Head
2 (Default)	2-division conducting
4	4-division conducting

- a = 116: Sets the paper specified by (nL+nH×256).

(nL+nH×256)	Paper
1 (Default)	Specified single color paper
257	Recommended 2-color paper

- a = 117: Sets paper width to the size specified by (nL+nH×256).

(nL+nH×256)	Paper Width
38	38mm
39	39mm
:	:
80 (Default)	80mm
81	81mm
82	82mm
83	83mm

[Caution]

- This function operates only in printer function setting mode.
- The value changed by this command is enabled by the following.
- Execution of function 2 (fn = 2: End of printer function setting mode) (Recommended)
- Reentering power supply.
- Hardware resetting by reset terminal

[Default]

Described in processing table for "a".

fn = 6: Function 6 Sending the Set Customized Value

GS (E pL pH fn a

[Code] <1D>H<28>H<45>H<pL><pH><fn>[a]

[Range] (pL+pH×256)=2 (pL=2、pH=0)
fn=6
a=1、2、5、6、97、116、117

[Outline] • Sends the set value of customized value set by "a".

	Hex.	No. of Data
Header	37H	1
ID	27H	1
Customized value No.	30H~39H	1~3
Separation number	1FH	1
Customized value	30H~39H	1~5
NULL	00H	1

• Configuration of customized value No.

a	Sending Data		
	1st Byte	2nd Byte	3rd Byte
1	49("1")	—	—
2	50("2")	—	—
5	53("5")	—	—
6	54("6")	—	—
97	57("9")	55("7")	—
116	49("1")	49("1")	54("6")
117	49("1")	49("1")	55("7")

• a = 1: When user NV memory capacity is specified*

Setting Status		Sending Data				
Stored Value	Memory Capacity	1st Byte	2nd Byte	3rd Byte	4th Byte	5th Byte
1	1K bytes	49("1")	—	—	—	—
2	64K bytes	50("2")	—	—	—	—
3	128K bytes	51("3")	—	—	—	—
4	192K bytes	52("4")	—	—	—	—

- a = 2: When NV graphics memory capacity is specified*

Setting Status		Sending Data				
Stored Value	Memory Capacity	1st Byte	2nd Byte	3rd Byte	4th Byte	5th Byte
1	None	49("1")	—	—	—	—
2	64K bytes	50("2")	—	—	—	—
3	128K bytes	51("3")	—	—	—	—
4	192K bytes	52("4")	—	—	—	—
5	256K bytes	53("5")	—	—	—	—
6	320K bytes	54("6")	—	—	—	—
7	384K bytes	55("7")	—	—	—	—

- a = 5: When print density is specified

Setting Status		Sending Data				
Stored Value	Print Density	1st Byte	2nd Byte	3rd Byte	4th Byte	5th Byte
65530	70%	54("6")	53("5")	53("5")	51("3")	48("0")
65531	75%	54("6")	53("5")	53("5")	51("3")	49("1")
65532	80%	54("6")	53("5")	53("5")	51("3")	50("2")
65533	85%	54("6")	53("5")	53("5")	51("3")	51("3")
65534	90%	54("6")	53("5")	53("5")	51("3")	52("4")
65535	95%	54("6")	53("5")	53("5")	51("3")	53("5")
0	Basic density	48("0")	—	—	—	—
1	105%	49("1")	—	—	—	—
2	110%	50("2")	—	—	—	—
3	115%	51("3")	—	—	—	—
4	120%	52("4")	—	—	—	—
5	125%	53("5")	—	—	—	—
6	130%	54("6")	—	—	—	—
7	135%	55("7")	—	—	—	—
8	140%	56("8")	—	—	—	—

- a = 6: When printing speed is specified

Setting Status		Sending Data				
Stored Value	Printing Speed	1st Byte	2nd Byte	3rd Byte	4th Byte	5th Byte
1	Speed level 1	49("1")	—	—	—	—
2	Speed level 2	50("2")	—	—	—	—
3	Speed level 3	51("3")	—	—	—	—
4	Speed level 4	52("4")	—	—	—	—
5	Speed level 5	53("5")	—	—	—	—
6	Speed level 6	54("6")	—	—	—	—
7	Speed level 7	55("7")	—	—	—	—
8	Speed level 8	56("8")	—	—	—	—
9	Speed level 9	57("9")	—	—	—	—

- a = 97: When number of divisions for head conducting is specified

Setting Status		Sending Data				
Stored Value	No. of Divisions	1st Byte	2nd Byte	3rd Byte	4th Byte	5th Byte
2	2 division conducting	50("2")	—	—	—	—
4	4 division conducting	52("4")	—	—	—	—

- a = 116: When kind of paper is specified

Setting Status		Sending Data				
Stored Value	Paper	1st Byte	2nd Byte	3rd Byte	4th Byte	5th Byte
1	Single-color	49("1")	—	—	—	—
257	2-color paper	50("2")	53("5")	55("7")	—	—

- a = 117: When paper width is specified

Setting Status		Sending Data				
Stored Value	Paper Width	1st Byte	2nd Byte	3rd Byte	4th Byte	5th Byte
38	38mm	51("3")	56("8")	—	—	—
39	39mm	51("3")	57("9")	—	—	—
:	:	:	:	—	—	—
80	80mm	56("8")	48("0")	—	—	—
81	81mm	56("8")	49("1")	—	—	—
82	82mm	56("8")	50("2")	—	—	—
83	83mm	56("8")	51("3")	—	—	—

fn = 7: Function 7 Copying User-defined Page

GS (E pL pH fn a d1 d2

[Code] <1D>H<28>H<45>H<pL><pH><fn><a>[d1 d2]

[Range] (pL+pH×256)=4 (pL=4, pH=0)
 fn=7
 a=10、12、17

[Outline] • Copies the data of user-defined code page in the font specified by "a".

a	Font Type
10	Font A: 12 (horizontal)×24 (vertical)
12	Font B: 9 (horizontal)×17 (vertical)
17	Font C: 8 (horizontal)×16 (vertical)

• Configuration of customized value No.

d1	d2	Function
31	30	Loads the character code page data specified by "a" in storage area to work area.
30	31	Saves the character code page data in work area to the storage area of the font specified by "a".

- Work area: Area where data is initialized by power OFF or resetting (initialize). Operation is made in accordance with the data set in this area.
- Storage area: Area where data is not initialized by power OFF or resetting (initialize).
- User-defined code page: Page 255 (ESC t 255)
- This function operates only in printer function setting mode.

fn = 8: Function 8 Defining Data by the Column Format to Character Code Page of Work Area

GS (E pL pH fn y c1 c2 [x d1...d(y×x)] k

[Code] <1D>H<28>H<45>H<pL><pH><fn><y><c1><c2>[x d1... d(y×x)]k

[Range] $5 \leq (pL + pH \times 256) \leq 65535$
 $fn = 8$
 $y = 2$ (At selection of font C)
 $y = 3$ (At selection of other than font C)
 $128 \leq c1 \leq c2 \leq 255$
 $0 \leq x \leq 12$ (At selection of font A)
 $0 \leq x \leq 9$ (At selection of font B)
 $0 \leq x \leq 8$ (At selection of font C)
 $0 \leq d \leq 255$
 $k = c2 - c1 + 1$

- [Outline]**
- Defines the data in column format in units of character on the code page in RAM.
 - Operates only in printer function setting mode.

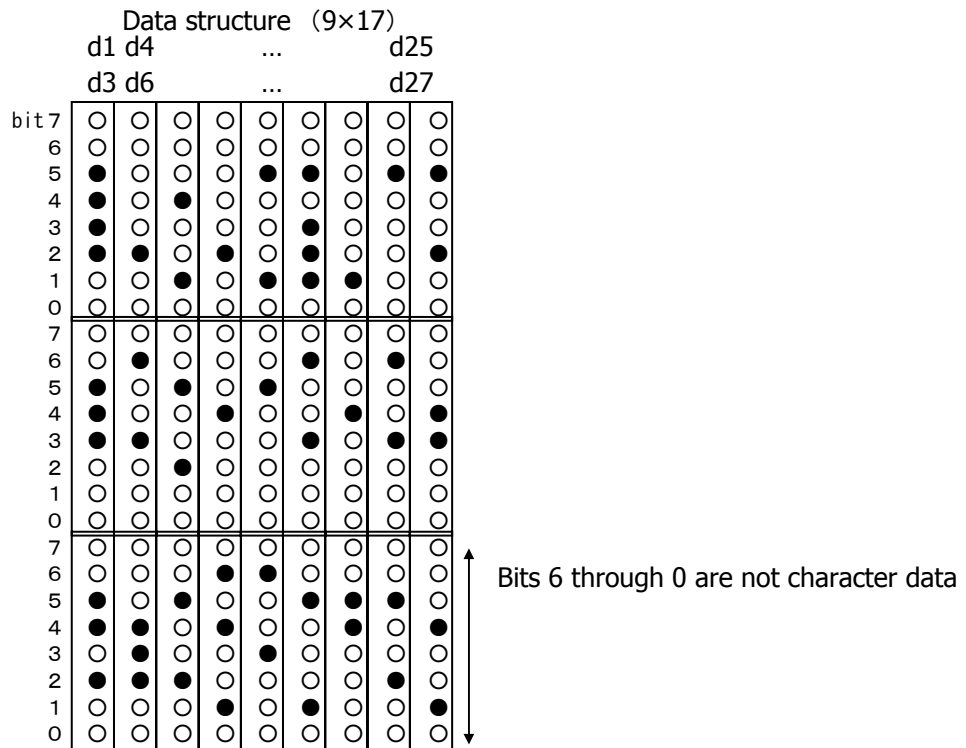

GS (E pL pH fn x c1 c2 [y d1...d(y×x)] k

[Code] <1D>H<28>H<45>H<pL><pH><fn><x><c1><c2>[y d1 ... d(y×x)]k

[Range] $5 \leq (pL + pH \times 256) \leq 65535$
 $fn = 9$
 $y = 1$ (At selection of font C)
 $y = 2$ (At selection of other than font C)
 $128 \leq c1 \leq c2 \leq 255$
 $0 \leq y \leq 24$ (At selection of font A)
 $0 \leq x \leq 17$ (At selection of font B)
 $0 \leq x \leq 16$ (At selection of font C)
 $0 \leq d \leq 255$
 $k = c2 - c1 + 1$

- [Outline]**
- Defines the data in raster format in units of character on the character code page in work area.
 - Operates only in printer function setting mode.

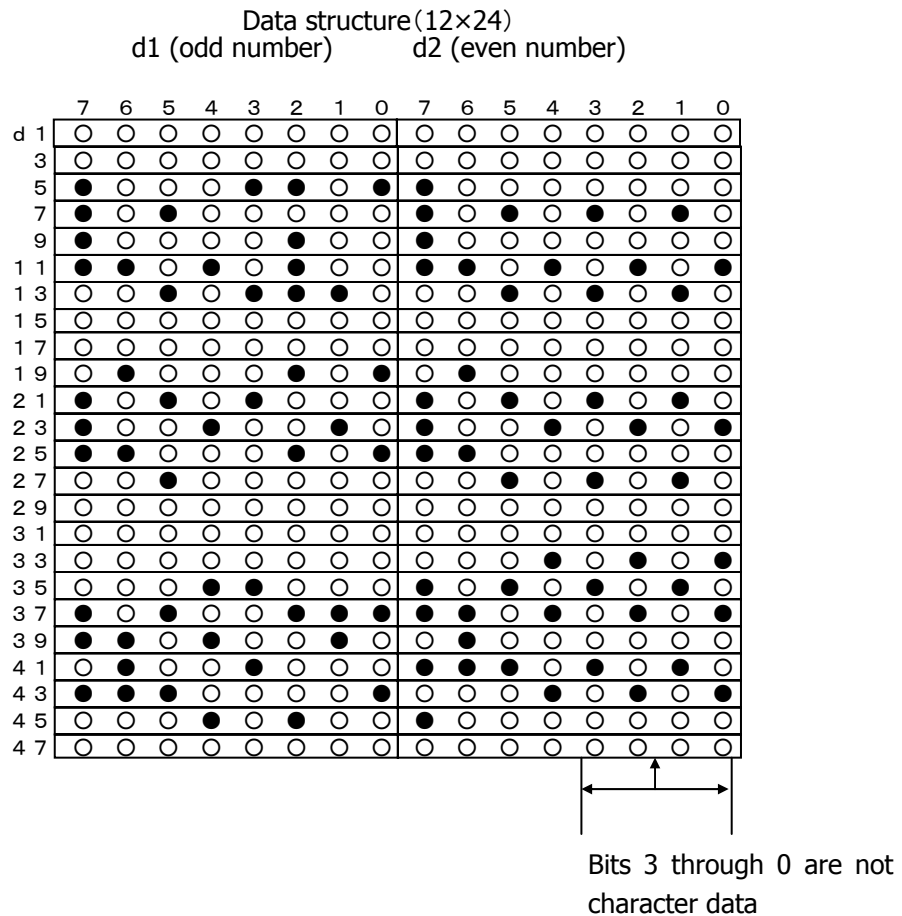

fn = 10: Function 10 Erasing Data of Character Code Page Data in Work Area

GS (E pL pH fn c1 c2

[Code] <1D>H<28>H<45>H<pL><pH><fn><c1><c2>

[Range] (pL+pH×256) = 3
fn = 10
 $128 \leq c1 \leq c2 \leq 255$

[Outline]

- Erases (set to space) data in units of character on the character code page in work area.
- Operates only in printer function setting mode.

fn = 11: Function 11 Setting Communication Conditions of Serial Interface

GS (E pL pH fn a d1 ... dk

[Code] <1D>H<28>H<45>H<pL><pH><fn><a>[d] k

[Range] $3 \leq (pL + pH \times 256) \leq 65535$ ($0 \leq pL \leq 255, 0 \leq pH \leq 255$)
 $fn = 11$
 $1 \leq a \leq 4$ (Not changed in other than specified range)
 $48 \leq d \leq 57$ (Not changed in other than specified range)
 $1 \leq k \leq 6$

[Outline] Sets the communication conditions of serial interface specified by "a".

- a = 1: Setting baud rate

Baud Rate	d1	d2	d3	d4	d5
2400	50("2")	52("4")	48("0")	48("0")	----
4800	52("4")	56("8")	48("0")	48("0")	----
9600	57("9")	54("6")	48("0")	48("0")	----
19200 (Default)	49("1")	57("9")	50("2")	48("0")	48("0")
38400	51("3")	56("8")	52("4")	48("0")	48("0")

- a = 2: Setting to specified parity

d1	Parity Setting
48 (Default)	No parity
49	Odd parity
50	Even parity

- a = 3: Setting to specified flow control

d1	Flow Control
48 (Default)	DSR/DTR
49	XON/XOFF

- a = 4: Setting to specified data length

d1	Setting Data Length
55	7-bit length
56 (Default)	8-bit length

- Operates only in printer function setting mode.
- Which of dip SW or memory SW is used at initialization depends on "Selecting communication condition setting" of dip SW1-1.

fn = 12: Function 12 Sending the Set Communication Conditions of Serial Interface

GS (E pL pH fn a

[Code] <1D>H<28>H<45>H<pL><pH><fn><a>

[Range] (pL + pH × 256) = 2 (pL = 2, pH = 0)
 fn = 12
 1 ≤ a ≤ 4 (Does not send in other than specified range)

[Outline] Sends communication conditions of serial interface specified by "a".

	Hex.	No. of Data
Header	37H	1
ID	33H	1
Kind of communication conditions (a)	31H("1") ~ 34H("4")	1
Separation number	1FH	1
Set value	30H ~ 39H	1 ~ 6
NULL	00H	1

Set value

• a = 1: At specification of baud rate

Baud Rate	d1	d2	d3	d4	d5	d6
2400	50("2")	52("4")	48("0")	48("0")	----	----
4800	52("4")	56("8")	48("0")	48("0")	----	----
9600	57("9")	54("6")	48("0")	48("0")	----	----
19200 (Default)	49("1")	57("9")	50("2")	48("0")	48("0")	----
38400	51("3")	56("8")	52("4")	48("0")	48("0")	----
57600*	53("5")	55("7")	54("6")	48("0")	48("0")	----
115200*	49("1")	49("1")	53("5")	50("2")	48("0")	48("0")

• a = 2: At specification of parity

d1	Parity Setting
48	No parity
49	Odd parity
50	Even parity

• a = 3: At specification of flow control

d1	Flow Control
48	DTR / DSR
49	XON / XOFF

• a = 4: Setting to specified data length

d1	Setting Data Length
48	7-bit length
49	8-bit length

fn = 48: Function 48 Erasing Paper Layout

GS (E pL pH fn d1 d2 d3

[Code]	<1D>H<28>H<45>H<pL><pH><fn><d1><d2><d3>
[Range]	(pL+pH×256)=4 (pL=4, pH=0) fn=48 d1=67("C") d2=76("L") d3=82("R")
[Outline]	<ul style="list-style-type: none">• Defines all set values of paper layout as "State of no setting".• Operates only in printer function setting mode.

fn = 49: Function 49 Setting Paper Layout

GS (E pL pH fn [a1] ; [bL bH] ; [cL cH] ; [dL dH] ; [eL eH] ; [fL fH] ; [gL gH] ; [hL hH] ;

[Code] <1D>H<28>H<45>H<pL><pH><fn>[a]<3B>H[bL bH]<3B>H[cL cH]<3B>H[dL dH]<3B>H[eL eH]<3B>H[fL fH]<3B>H[gL gH]<3B>H[hL hH]<3B>H

[Range] $9 \leq (pL + pH \times 256) \leq 24$ ($9 \leq pL \leq 24$, $pH = 0$)
 $fn = 49$
 $a = 48, 49$
 $100 \leq (bL + bH \times 256) \leq 3000$, $35 \leq (cL + cH \times 256) \leq 100$
 $0 \leq (dL + dH \times 256) < 3000$, $0 \leq (eL + eH \times 256) < 3000$
 $38 \leq (fL + fH \times 256) \leq 3000$, $27 \leq (gL + gH \times 256) \leq 533$
 $240 \leq (hL + hH \times 256) \leq 720$

When any of the following is met, the parameter is illegal and the command is ignored.
 $(bL + bH \times 256) \leq ((cL + cH \times 256) + 35)$
 $(bL + bH \times 256) < (dL + dH \times 256)$
 $(bL + bH \times 256) < (eL + eH \times 256)$
 $(bL + bH \times 256) < (fL + fH \times 256)$
 Paper size $< ((gL + gH \times 256) + ((hL + hH \times 256) + 34))$

[Outline] Sets paper layout.
 Sets vertical layout (bL, bH-fL, fH) and horizontal layout (gL, gH, hL, hH) in units of 1 mm.
 Operates only in printer function setting mode.

- Sets "paper type" by a.

a	Paper Type
48	Receipt (without black mark)
49	Receipt (with black mark added)

- Sets "vertical layout" with bL, bH-fL, fH.

	When a = 49 is Specified
bL, bH	Distance from black mark top end to next black mark top end
cL, cH	Distance from black mark top end to black mark bottom end
dL, dH	Distance from black mark top end to initial position
eL, eH	Distance from black mark top end to cut position
fL, fH	Distance from initial position to print area bottom end

- Sets "horizontal layout" with gL, gH, hL, hH.

	When a = 49 is Specified
gL, gH	Distance from paper left end to print area left end
hL, hH	Distance from print area left end to print area right end

[Default] All settings are "State of no setting"

- Configuration of "Layout information"

n	Transmission Data				
	1st Byte	2nd Byte	3rd Byte	4th Byte	5th Byte
64	54("6")	52("4")	—	—	—
80	56("8")	48("0")	—	—	—

- Configuration of "Layout information type"
- Converts the information on each layout into character code expressed in decimal notation and sends it from the higher digit.
- Symbols (a to h) of transmission data correspond to (a and bL, bH-hL, hH) of Function 49.
- When the set value is specified (n = 64), the set value of Function 49 or GS (A (Automatic setting of paper layout) is sent.
- When effective value is specified (n = 80), the value used in actual operation is sent in accordance with the set value of Function 49 or GS (A (Automatic setting of paper layout).
- Layout information that has not been set is not sent.

fn = 255: Function 255 Setting All Contents Set by Printer Function Setting Mode to the State at Shipment

GS (E pL pH fn a

[Code] <1D>H<28>H<45>H<pL><pH><fn><a>

[Range] (pL+pH×256)=2 (pL=2、pH=0)
fn=255
a=3、5、7、11、255

[Outline] Restores various kinds of function set by printer function setting mode to the setting at the time of shipment (initial value described in User's Manual).

a	Function
3	Memory switch
5	Customized value
7	Character code
11	Communication conditions of serial interface
255	Sets all contents set in printer function setting mode to the state at the time of shipment.

GS (K pL pH fn m

[Function] Selecting print control method

[Outline] Executes the setting related to the print control specified by the value of "fn".

Function No. (fn)	Function
Function 48	Sets print control mode.
Function 49	Sets printing density.
Function 50	Sets printing speed.
Function 97	Sets the number of divisions for head conducting.

fn = 48: Function 48 Setting Print Control Mode

GS (K pL pH fn m

[Code] <1D>H<28>H<4B>H<pL><pH><fn><m>

[Range] (pL+pH×256)=2 (pL=2, pH=0)
fn=48
 $0 \leq m \leq 4, 48 \leq m \leq 52$

[Outline] Sets print control mode.

m	Print Control Mode
0,48	Selects the print control mode at power on.
1,49	Sets print control mode 1 (standard)
2,50	Selects the print control mode at power on.
3,51	Selects the print control mode at power on.
4,52	Selects the print control mode at power on.

[Default] m=1

fn = 49: Function 49 Setting Printing Density

GS (K pL pH fn m

[Code] <1D>H<28>H<4B>H<pL><pH><fn><m>

[Range] (pL+pH×256)=2 (pL=2, pH=0)
fn=49
0≤m≤8, 250≤m≤255

[Outline] Sets printing density.

m	Printing Density
250	Selects density level -6 (70%)
251	Selects density level -5 (75%)
252	Selects density level -4 (80%)
253	Selects density level -3 (85%)
254	Selects density level -2 (90%)
255	Selects density level -1 (95%)
0	Selects standard density (100%)
1	Selects density level +1 (105%)
2	Selects density level +2 (110%)
3	Selects density level +3 (115%)
4	Selects density level +4 (120%)
5	Selects density level +5 (125%)
6	Selects density level +6 (130%)
7	Selects density level +7 (135%)
8	Selects density level +8 (140%)

[Default] m = 0 (Customized value setting value)

fn = 50: Function 50 Setting Printing Speed

GS (K pL pH fn m

[Code] <1D>H<28>H<4B>H<pL><pH><fn><m>

[Range] (pL+pH×256)=2 (pL=2, pH=0)
fn=50
0≤m≤9, 48≤m≤57

[Outline] Sets printing speed.

m	Printing Speed
0,48	Selects print control mode at power on.
1,49	Selects printing speed level 1.
2,50	Selects printing speed level 2.
3,51	Selects printing speed level 3.
4,52	Selects printing speed level 4.
5,53	Selects printing speed level 5.
6,54	Selects printing speed level 6.
7,55	Selects printing speed level 7.
8,56	Selects printing speed level 8.
9,57	Selects printing speed level 9.

[Default] m = 0 (Customized value setting value)

fn = 97: Function 97 Setting Number of Divisions for Head Conducting

GS (K pL pH fn m

[Code] <1D>H<28>H<4B>H<pL><pH><fn><m>

[Range] (pL+pH×256)=2 (pL=2, pH=0)
fn=97
m=0, 2, 4, 48, 50, 52

[Outline] Sets the number of divisions for head conducting.

m	No. of Divisions for Head Conducting
0,48	No. of divisions at power on.
2,50	Selects 2-division conducting.
4,52	Selects 4-division conducting.

[Default] m = 0 (Customized value setting value)

GS (M pL pH fn m

[Function] Customizing the printer

[Outline] Executes processing related to escape/recovery of the value set in the work area or the data defined by various kinds of command.

Function (fn)	Function
Function 1	Copies the set value stored in work area to the storage area.
Function 2	Copies the set value stored in storage area to the work area.
Function 3	Specifies the auto loading function of the set value at initialization to be valid or invalid.

- Work area: Area where data is initialized by power OFF of resetting (initialize). Operation is made in accordance with the data set in this area.
- Storage area: Area where data is not initialized by power OFF or resetting (initialize).

Commands for this function

Command Type	Command
Status relations	ESC c 3, GS a
Macro registration	GS :
Character type	ESC M, ESC R, ESC t
Font attribute	ESC !, ESC -, ESC E, ESC G, ESC V, ESC { , GS !, GS B, GS b, GS (N
Line feed amount, character space	ESC SP, ESC 2, ESC 3
Barcode	GS H, GS f, GS h, GS w
Print position	ESC D, ESC T, ESC a, GS L, GS W
Other	ESC c 4, ESC c 5, GS (D, GS P

fn = 1, 49: Function 1 Copies the set value stored in work area to the storage area

GS (M pL pH fn m

[Code] <1D>H<28>H<4D>H<pL><pH><fn><m>

[Range] (pL+pH×256)=2 (pL=2、pH=0)
fn=1、49
m=1、49

[Outline] Copies the set value stored in work area to the storage area.

[Caution]

- This command allows writing to non-volatile memory. Therefore, using this command frequently may result in breakage of non-volatile memory. Use this command appropriately [10 times max./day].
- During execution of this command, the printer is in Busy state and stops receiving operation. Therefore, data transmission from the host is prohibited.

fn = 2, 50: Function 2 Copies the set value stored in storage area to the work area

GS (M pL pH fn m

[Code] <1D>H<28>H<4D>H<pL><pH><fn><m>

[Range] (pL+pH×256)=2 (pL=2、pH=0)
fn=2、50
m=0、1、48、49

[Outline] Changes the set value of work area by the value of "m".

m	Function
0,48	Sets all set values of work area to the initial value described in the specification.
1,49	Copies the set value stored in storage area to the work area. When there is no set value in storage area, sets the value to the initial value described in the specification.

fn = 3, 51: Function 3 Specifies the auto loading function of the set value at initialization to be valid or invalid

GS (M pL pH fn m

[Code] <1D>H<28>H<4D>H<pL><pH><fn><m>

[Range] (pL+pH×256)=2 (pL=2、pH=0)
fn=3、51
m=0、1、48、49

[Outline] Determines the setting of storage area at initialization to the work area by the value of "m".

m	Function
0,48	Does not copy data from storage area to work area at initialization.
1,49	Copies data from storage area to work area at initialization.

GS (N pL pH fn m

[Function] Designating font attribute

[Outline] Executes processing of font attribute by the specified "fn" value.

Function No. (fn)	Function
48	Selects character color.

fn = 48: Function 48 Selects character color

GS (N pL pH fn m

[Code] <1D>H<28>H<4E>H<pL><pH><fn><m>

[Range] $(pL + pH \times 256) = 2$ (pL=2, pH=0)
fn=48
m=49 (At single color paper setting)
m=49, 50 (At 2-color paper setting)

[Outline] Prints the succeeding characters with the energy set in "m".

m	Function
49	High energy
50	Low energy

[Default] m=49

2.2.14 Special Commands

ESC n n

- [Function]** Setting the remaining amount of printout
- [Code]** <1B>H<6E>H<n>
- [Range]** $0 \leq n \leq 255$ ("n" in the 3rd byte denotes this command.)
- [Outline]** • This command sets the remaining amount of printout after detecting paper near-end1.
• "n" is set in cm.
- [Caution]** • If the paper near-end (PNE) sensor is disabled, this command has no function.
• The set value and the remaining amount of printout are not cleared by the initialize command (ESC @).
• If a value lower than the preset value is set during PNE detection, the printer may stop printing.
• The set value remains valid until the printer is restarted or a new value is set.
- [Default]** n = 150 (150 cm)
- [Sample Program]**
LPRINT CHR\$(&H1B); CHR\$(&H6E); CHR\$(100);

ESC Y n1 n2

- [Function]** Specifying length of paper feed after black mark detection
- [Code]** <1B>H<59>H<n1><n2>
- [Range]** $0 \leq n1 \leq 255$
 $0 \leq n2 \leq 3$
Length of paper feeding = $(n1 + 256 \times n2) \times 1/203$ inch
- [Outline]** • This command specifies length of paper feeding after detecting black mark for 0 mm to 127.875 mm by $(n1 + 256 \times n2) \times 1/203$ inch
• If length of paper feed is specified by this command and when printer receives GS+S (Black mark detection command), printer feeds paper for the specified length after detecting black mark.
- [Default]** n=0

GS R 0

[Function] Collect the receipt

[Code] <1D>H<52>H<30>H

[Outline]

- This command have the presenter collect receipt to the direction set by MSW4-5.
- When printer receives this command, if presenter sensor detects paper presence, motor is activated till sensor detects no paper.
- When printer receives this command, if presenter sensor detects no paper, motor is activated 5 second and stop.

[Caution]

- When memory switch 4-4 is OFF, this command is ignored.
- If collection timer is set by GS+R+1+n and printer receives this command before the time, this command have the presenter collects the receipt.

GS R 1 n

[Function] Setting receipt collection timer

[Code] <1D>H<52>H<31>H<n>

[Range] $0 \leq n \leq 9$

[Outline]

- This command sets the time from ejecting a receipt till collecting it to $(n \times 1 \text{ sec})$.
- When $n = 0$, this command does not set the time. (Use GS R 0 command for Receipt collection)

[Caution] When memory switch 4-4 is OFF, this command is ignored.

[Default] $n = 5$ (5 sec)

[Sample Program]

```
LPRINT CHR$(&H1D); CHR$(&H52); CHR$(&H31); CHR$(1);
```

GS S

[Function] Detecting a black mark

[Code] <1D>H<53>H

[Outline] This commands detects a black mark when black mark paper is set.

[Caution]

- When memory switch 3-4 is OFF, this command is ignored.
- When this command is received during detection of a black mark, the next black mark is detected and the print paper is cut and then ejected.
- Also at the time of printer power on, a black mark is detected and the print paper is cut and ejected.
- If no black mark is detected in the 18-inch long paper, black mark detection error occurs, causing BUSY and FAULT or DTR to be output and the print paper to be cut and then ejected.

[See Also] [Appendix 4.5 "Black Mark Layout and Operating Condition"](#)

[Sample Program]

```
LPRINT CHR$(&H1D); CHR$(&H53);
```

FS (L pL pH fn m

[Function] Controlling black mark paper

[Outline] Executes various kinds of control for black mark paper.
• Executes the function specified by the function code (fn).

Function No.	Function
Function 48	Sends position information.
Function 66	Executes paper feeding to the cut position.
Function 67	Executes paper feeding to the initial position.

fn = 48: Function 48 Sending Position Information

FS (L pL pH fn m

[Code] <1C>H<28>H<4C>H<pL><pH><fn><m>

[Range] (pL+pH×256)=2 (pL=2、pH=0)
fn=48
m=48

[Outline] Sends the position information of black mark paper.

Transmission Data	Hex.	Decimal	Data Size
Header	37H	55	1 byte
Identifier	38H	56	1 byte
Position information A	40H~47H	64~71	1 byte
Position information B	40H~43H	64~67	1 byte
NULL	00H	0	1 byte

• Position information A

Bit	Function	Hex.	Decimal
0	Fixed	00	0
1	Relation with cut position: Not cut position	00	0
	Relation with cut position: Standby at cut position	02	2
2	Relation with initial position: Not initial position	00	0
	Relation with initial position: Standby at initial position	04	4
3~5	Reserved	00	0
6	Fixed	40	64
7	Fixed	00	0

• Position information B

Bit	Function	Hex.	Decimal
0	Fixed	01	0
1	Next initialize operation is possible.	00	0
	Next initialize operation is impossible.	02	2
2~5	Reserved	00	0
6	Fixed	40	64
7	Fixed	00	0

fn = 66: Function 66 Executing Paper Feeding to Cut Position

FS (L pL pH fn m

[Code] <1C>H<28>H<4C>H<pL><pH><fn><m>

[Range] (pL+pH×256)=2 (pL=2、pH=0)
fn=66
m=48、49

[Outline] Executing paper feeding to the cut position.

m	Operation
48	Executes paper feeding to the next cut position. When, however, the printer has already been standby at the cut position, no operation is executed.
49	Executes paper feeding to the next cut position. When, however, the printer has already been standby at the cut position, paper feeding to the next cut position is executed.

fn = 67: Function 67 Executing Paper Feeding to Initial Position

FS (L pL pH fn m

[Code] <1C>H<28>H<4C>H<pL><pH><fn><m>

[Range] (pL+pH×256)=2 (pL=2、pH=0)
fn=67
m=48、49

[Outline] Executing paper feeding to initial position.

m	Operation
48	Executes paper feeding to the next initial position. When, however, the printer has already been standby at the initial position, no operation is executed.
49	Executes paper feeding to the next initial position. When, however, the printer has already been standby at the initial position, paper feeding to the next initial position is executed.

2.2.15 Other Commands

DLE ENQ n

[Function] Real-time request to printer

[Code] <10>H<05>H<n>

[Range] $0 \leq n \leq 2$

[Outline] The printer responds in real-time to the request that the host specifies with number "n".

n	Function
0	At the setting of execution of GS ^ by the FEED switch, the same processing as that pressing the FEED switch once is carried out.
1	After recovering from an error, the printer resumes printing from the beginning of the line where the error occurred.
2	The printer clears the receive buffer and the print buffer, and then recovers from the error.

- [Caution]**
- (n = 1) or (n = 2) shall be used after removing the error.
 - When receiving a code row coinciding with the code configuring this command, the same operation as this command takes place and attention by the user is required.
Example: When corresponding code row is present in bit image data.
 - This command must not be used between other command code rows.
Example: This command is used in the bit image data.
 - This command is ignored during transmission of block data.

[See Also] [DLE EOT](#)

DLE DC4 fn m t (Specification of fn = 8)

[Function] Buffer clear

[Code] <10>H<14>H<fn><d1>...<d7>

[Range] fn=8, d1=1, d2=3, d3=20, d4=1, d5=6, d6=2, d7=8

- [Outline]**
- Erases all data in receiving buffer or print buffer.
 - Sends the following 3-byte data group.

	Hex.	Decimal	No. of Data
Header	37H	55	1 byte
Identifier	25H	37	1 byte
NUL	00H	0	1 byte

- Enters the state of selecting STANDARD MODE.

- [Caution]**
- When receiving a code row coinciding with the code configuring this command, the same operation as this command takes place and attention by the user is required.
Example: When corresponding code row is present in bit image data.
 - This command must not be used between other command code rows.
Example: This command is used in bit image data.
 - This command is ignored during transmission of block data.

ESC = n

[Function] Data input control

[Code] <1B>H<3D>H<n>

[Range] $0 \leq n \leq 255$

- [Outline]**
- Selecting equipment for which data input from the host is valid.
 - Each bit of "n" indicates as follows.
 - When the printer has not been selected, this printer abandons all the received data until it is selected by this command.

Bit	Equipment	Value	
		0	1
0	Printer	Invalid	Valid
1	Not defined	---	---
2	Not defined	---	---
3	Not defined	---	---
4	Not defined	---	---
5	Not defined	---	---
6	Not defined	---	---
7	Not defined	---	---

- [Caution]**
- Even when the printer has not been selected, it can become BUSY state through printer operation.
 - When the printer is deselected, this printer discards all the data until it is selected with this command. (Except DLE EOT, DLE ENQ, and DLE DC4)

[Default] n=1

ESC @

[Function] Initializing the printer

[Code] <1B>H<40>H

[Outline] Clears data stored in the print buffer and brings various settings to the initial state (Default state).

- [Caution]**
- The settings of DIP switches are not read again.
 - Data inside the internal input buffer is not cleared.
 - Macro definitions are not cleared.
 - NV bit image definitions are not cleared.
 - Data in the user NV memory is not cleared.

[Sample Program]

```
LPRINT CHR$(&H1B);"!";CHR$(&H30);  
LPRINT CHR$(&H1B);"V";CHR$(1);  
LPRINT "AAA";CHR$(&HA);  
LPRINT CHR$(&H1B);"@";  
LPRINT "AAA";CHR$(&HA);
```

[Print Results]

▷▷▷

AAA

Each setting has been initialized by this command.

ESC L

[Function] Selecting PAGE MODE

[Code] <1B>H<4C>H

[Outline] Switches from STANDARD MODE to PAGE MODE.

- [Caution]**
- This command is only effective if it entered at the beginning of a line.
 - This command is not effective if it is entered when in PAGE MODE.
 - STANDARD MODE is restored when printing specified by FF is finished or when ESC S is issued.
 - The character mapping start position will be the point specified by ESC T in the print area specified by ESC W.
 - The commands listed below, which have separate settings for PAGE MODE and STANDARD MODE, are changed to the settings for PAGE MODE use.
 - (1) Spacing setting: ESC SP, FS S
 - (2) Line feed width setting: ESC 2, ESC 3
 - The following commands are valid only in PAGE MODE.
 - (1) ESC V Specifying/canceling 90°-right-turned characters.
 - (2) ESC a Aligning the characters.
 - (3) ESC { Specifying/canceling the inverted characters.
 - (4) GS L Setting the left margin.
 - (5) G3S W Setting the print area width.
 - The following commands are disabled in PAGE MODE.
 - (1) GS (A Executes test printing.
 - (2) FS P Prints NV memory bit image.
 - (3) FS q Defines NV memory bit image.
 - (4) GS v 0 Prints raster bit image.
 - ESC @ restores STANDARD MODE.

[See Also] [Appendix 4.1.4 "Example of using PAGE MODE"](#)
[FF](#), [CAN](#), [ESC FF](#), [ESC S](#), [ESC T](#), [ESC W](#), [GS W](#), [GS \](#)

ESC S

[Function] Selecting STANDARD MODE

[Code] <1B>H<53>H

[Outline] Switches from PAGE MODE to STANDARD MODE.

- [Caution]**
- This command is only effective if it is entered when in PAGE MODE.
 - Any data mapped in PAGE MODE is erased.
 - After this command is executed, the beginning of the line is taken as the next print start position.
 - The print area defined by ESC W is initialized.
 - The commands listed below, which have separate settings for STANDARD MODE and PAGE MODE, are changed to the settings for STANDARD MODE use.
 - (1) Spacing setting: ESC SP, FS S
 - (2) Line feed width setting: ESC 2, ESC 3
 - The following commands are valid only in setting in STANDARD MODE.
 - (1) ESC W Sets the space amount for setting print area in PAGE MODE.
 - (2) ESC T Selects the printing direction of character in PAGE MODE.
 - (3) GS \$ Sets the absolute position of character vertical direction in PAGE MODE.
 - STANDARD MODE is selected when the printer is turned on or reset, or when ESC @ is executed.

[See Also] [FE](#), [ESC FE](#), [ESC L](#)

ESC RS

[Function] Sound buzzer

[Code] <1B>H<1E>H

[Outline] Sound the buzzer for 200 ms.

- [Caution]**
- This command is buffered before execution.
 - This command is ignored when MSW3-7 is ON.

[Sample Program]

```
LPRINT CHR$(&H1B); CHR$(&H1E);
```

[Execution Result]

The buzzer sounds for approx. 200 ms.

GS (A pL pH n m

[Function] Execution of test printing

[Range] $(pL + (pH \times 256)) = 2$ ($pL=2, pH=0$)
 $0 \leq n \leq 2, 48 \leq n \leq 50$
 $1 \leq m \leq 7, 49 \leq m \leq 55$

[Outline] Specified test printing will be executed.

- pL, pH will specify the number of subsequent parameters by $(pL + (pH \times 256))$ bytes.
- "n" will specify the paper for test printing in the following table.

n	Paper Type
0,48	Basic paper (Paper rolls)
1,49 2,50	Paper rolls

- "m" specifies the type of test printing shown in the following table.

m	Test Printing Type
1,49	Hexadecimal dump
2,50	Printer's status printing
3,51	Rolling pattern printing
4,52	Demo pattern printing
5,53	Printer status concatenated printing
6,54	Rolling pattern concatenated printing
7,55	Demo pattern concatenated printing

[Caution]

- This command is only valid when processed at the head of a line during the STANDARD MODE.
- The command will be ignored in PAGE MODE.
- During macro definition, if this command is processed, the macro definition is suspended, and the command starts being processed.
- Printer will reset its hard disk after finishing test printing. Therefore, the printer makes download characters, bit map images and macros undefined, clears the reception buffer/print buffer, and returns the various settings to defaults. At this time, the DIP switches are read again.
- Paper cutting is performed at the end of test printing.
- Printer will be BUSY when the processing of the command starts.

GS I n

[Function] Sending the printer ID

[Code] <1D>H<49>H<n>

[Range] $1 \leq n \leq 4$, $49 \leq n \leq 52$, $65 \leq n \leq 69$

[Outline] Sends the specified printer ID.

n	Type of Printer ID	Specification	Value (Hex.)
1,49	Model ID	PPU-700	30
2,50	Type ID	Refer to table "Type ID" below	
3,51	ROM version ID	Subject to ROM version	
4,52	Black mark length	Depends on Black mark paper (mm)	

Sends the specified printer information.

n	Kind of Printer Information	Information
65	Firmware version	Differs by firmware version.
66	Manufacturer name	CBM
67	Model name	PPU-700
68	Serial number	Subject to serial number
69	Kinds of multi-language fonts	Japanese Kanji specifications: KANJI Chinese Specifications: GB-18030 Chinese Specifications: GB-2312 Thai Specifications: THAI 3 PASS Korean Specifications: KOREA C-5601C

Type ID If n = 2, 50 is specified:

Bit	Meaning	Hex.	Decimal
0	Does not support 2-byte code	00	0
	Supports 2-byte code.	01	1
1	Without auto-cutter	00	0
	With auto-cutter	02	2
2	Thermal paper	00	0
	Black mark paper (when Black mark paper is selected)	04	4
3	Without presenter	00	0
	With presenter	08	8
4	Unused	00	0
5	Undefined	---	---
6	Undefined	---	---
7	Unused	00	0

n = 4, 52 specified (only for B.M specs)

The Black mark length and mark interval currently used are returned in 4-byte code.

All fractional parts in millimeters are rounded off.

Byte 1 + Byte 2 × 256 = Black mark interval

Byte 3 + Byte 4 × 256 = Black mark length

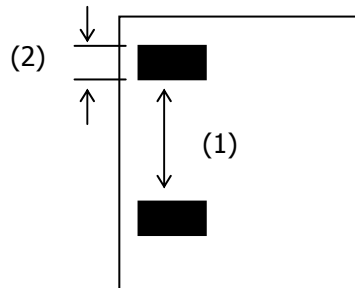

Black mark paper

[Caution]

- Under DTR/DSR control, the printer sends the printer ID after verifying that the host is ready to receive.
- Sending the Black mark length is valid only when Black mark paper is selected. If the host is not ready to receive, the printer waits for the host to become ready to receive.
- Under XON/XOFF control, the printer sends the printer ID without checking whether or not the host is ready to receive.
- Because this command is executed when data is mapped in the receive buffer, there may be a delay between command receiving and printer ID sending depending on the condition of the receive buffer.
- If ASB (Automatic Status Back) is enabled by GS a, the host must discriminate between the printer ID due to this command and the status due to ASB.

GS P x y

[Function]	Specifying the basic calculation pitch
[Code]	<1D>H<50>H<x><y>
[Range]	$0 \leq x \leq 255$, $0 \leq y \leq 255$
[Outline]	<ul style="list-style-type: none">• This command sets the horizontal basic calculation pitch to approx. 25.4/x mm (1/x inches), and the vertical basic calculation pitch to approx. 25.4/y mm (1/y inches).• If x = 0, the horizontal basic calculation pitch is reverted to the default value.• If y = 0, the vertical basic calculation pitch is reverted to the default value.
[Caution]	<ul style="list-style-type: none">• The horizontal direction is defined as the direction perpendicular to the paper feed, and the vertical direction is defined as the paper feed direction.• In STANDARD MODE, the following parameters are used regardless of the character orientation (e.g. inverted or 90°-right-turned).<ul style="list-style-type: none">(1) Commands using x: ESC SP, ESC \$, ESC \, FS S, GS L, GS W(2) Commands using y: ESC 3, ESC J• In PAGE MODE, the parameters used depend on the character orientation, as follows:<ul style="list-style-type: none">(1) If the start point specified by ESC T is the top left or bottom right (The characters are mapped in the direction perpendicular to the paper feed):<ul style="list-style-type: none">• Commands using x: ESC SP, ESC \$, ESC W, ESC \, FS S• Commands using y: ESC 3, ESC J, ESC W, GS \$, GS \(2) If the start point specified by ESC T is the top right or bottom left (The characters are mapped in the paper feed direction):<ul style="list-style-type: none">• Commands using x: ESC 3, ESC J, ESC W, GS \$, GS \• Commands using y: ESC SP, ESC \$, ESC W, ESC \, FS S• This command does not affect any other values that are already set.• If calculations made in combination with another command generate fractions, the fractions are corrected with the minimum pitch of the mechanism, and the remainder is omitted.
[Default]	x=203, y=203
[See Also]	Appendix 4.1 "Explanation on PAGE MODE" ESC SP , ESC \$, ESC 3 , ESC J , ESC W , ESC \ , GS \$, GS L , GS W , GS \

GS (L pL pH m fn [parameter]

GS 8 L p1 p2 p3 p4 m fn [parameter]

[Function] Specifying graphics data

[Code] <1D>H<28>H<4C>H<pL><pH><m><fn>
<1D>H<38>H<4C>H<p1><p2><p3><p4><m><fn>

* In the explanation of function, the code of GS (L is used.

- GS (L and GS 8 L) are the same function.
- When [parameter] exceeds 65533 bytes in each function, GS 8 L is used.

[Outline] Executes the processing related to the graphics data specified by the function code (fn).

fn	Code	Function No.	Function.
0,48	GS (L pL pH m fn	Function 48	Sends NV graphics memory capacity.
2,50	GS (L pL pH m fn	Function 50	Prints graphics data stored in print buffer.
3,51	GS (L pL pH m fn	Function 51	Sends the remaining amount of NV graphics memory.
64	GS (L pL pH m fn d1 d2	Function 64	Sends key code list of defined NV graphics.
65	GS (L pL pH m fn d1 d2 d3	Function 65	Erases all data of NV graphics in a lump.
66	GS (L pL pH m fn kc1 kc2	Function 66	Erases the specified NV graphics data.
67	GS (L pL pH m fn a kc1 kc2 b xL xH yL yH [c d1...dk]1...[c d1...dk]b	Function 67	Defines raster graphics data to NV memory.
69	GS (L pL pH m fn kc1 kc2 x y	Function 69	Prints the specified NV graphics.
112	GS (L pL pH m fn a bx by c xL xH yL yH d1...dk	Function 112	Stores raster graphics data to print buffer.

- pL, pH specifies the number of bytes or "m" and later to (pL+pH×256).

[Caution]

- Frequent use of this command may result in damage of NV memory. Use the Write command to NV memory in consideration of [10 times max./day].
- Following the processing of this command, printer Busy may occur during writing data in NV memory. While the printer is Busy, it stops receiving process. Therefore, data transmission (including real-time command) from host is prohibited.

fn = 0, 48: Function 48 Sending NV Graphics Memory Capacity

GS (L pL pH m fn

[Code] <1D>H<28>H<4C>H<pL><pH><m><fn>

[Range] $(pL + pH \times 256) = 2$ (pL=2, pH=0)
m=48
fn=0, 48

[Outline] Sends all capacity of NV graphics area in the number of bytes.

	Hex.	Decimal	Data Size
Header	37H	55	1 byte
Identifier	30H	48	1 byte
Data	30H~39H	48~57	1~8 bytes
NUL	00H	0	1 byte

- Converts all capacity to character code expressed in decimal notation and sends it from higher digit.
- Data size is variable.
- All definition area can be specified by GS (E out of [0, 64K, 128K, 192K, 256K, 320K, 384K]. Default value is 384k bytes.

fn = 2, 50: Function 50 Printing Graphics Data Stored in Print Buffer

GS (L pL pH m fn

[Code] <1D>H<28>H<4C>H<pL><pH><m><fn>

[Range] $(pL + pH \times 256) = 2$ (pL=2, pH=0)
m=48
fn=2, 50

[Outline]

- Prints the graphics data stored in the print buffer in the processing of Function 112.
- Executes paper feeding corresponding to the number of dots in Y direction of graphics stored in the print buffer.

fn = 3, 51: Function 51 Sending the Remaining Amount of NV Graphics Memory

GS (L pL pH m fn

[Code] <1D>H<28>H<4C>H<pL><pH><m><fn>

[Range] $(pL + pH \times 256) = 2$ (pL=2, pH=0)
m=48
fn=3, 51

[Outline] Sends the remaining amount of NV graphics area (number of bytes of unused area).

	Hex.	Decimal	Data Size
Header	37H	55	1 byte
Identifier	31H	49	1 byte
Data	30H~39H	48~57	1~8 byte
NUL	00H	0	1 byte

- Converts the remaining amount to character code expressed in decimal notation and sends it from higher digit.
- Data size is variable.

fn = 64: Function 64 Sending Key Code List of Defined NV Graphics

GS (L pL pH m fn d1 d2

[Code] <1D>H<28>H<4C>H<pL><pH><m><fn><d1><d2>

[Range] (pL+pH×256)=4 (pL=4, pH=0)
 m=48
 fn=64
 d1=75("K")
 d2=67("C")

[Outline] Sends the key code list of defined NV graphics.

- When key code list is present

	Hex.	Decimal	Data Size
Header	37H	55	1 byte
Identifier	72H	114	1 byte
Status	40H or 41H	64 or 65	1 byte
Data	30H~39H	48~57	2~80 bytes
NUL	00H	0	1 byte

- When key code is not present

	Hex.	Decimal	Data Size
Header	37H	55	1 byte
Identifier	72H	114	1 byte
Status	40H	64	1 byte
NULL	00H	0	1 byte

When 40 or more key codes are present, they are sent by being divided in unit of 40 max.

- Status with continuous transmission data group is 41H.
- Status without continuous transmission data group is 40H.

After sending [Header - NUL], receives a response from the host and executes the next processing corresponding to the response.

- In case of "Status (with continuous block): hexadecimal number = 41H / decimal number = 65"

Response		Content of Processing
ASCII	Decimal	
ACK	6	Sends next data group.
NAK	21	Resends previous data group.
CAN	24	Cancels processing.

- In case of "Status (last block): hexadecimal number = 40H / decimal number = 64"

Response		Content of Processing
ASCII	Decimal	
ACK	6	Terminates processing
NAK	21	Resends previous data group.
CAN	24	Cancels processing.

fn = 65: Function 65 Erasing All Data of NV Graphics in a Lump

GS (L pL pH m fn d1 d2 d3

[Code] <1D>H<28>H<4C>H<pL><pH><m><fn><d1><d2><d3>

[Range] (pL+pH×256)=5 (pL=5, pH=0)
m=48
fn=65
d1=67("C")
d2=76("L")
d3=82("R")

[Outline] Erases all defined data of NV graphics in a lump.

fn = 66: Function 66 Erasing Specified NV Graphics Data

GS (L pL pH m fn kc1 kc2

[Code] <1D>H<28>H<4C>H<pL><pH><m><fn><kc1><kc2>

[Range] (pL+pH×256)=4 (pL=4, pH=0)
m=48
fn=66
32≤kc1≤126
32≤kc2≤126

[Outline] Erases the NV graphics data defined by key code (kc1, kc2).

fn = 67: Function 67 Defining Raster Type Graphics Data to NV Memory

GS (L pL pH m fn a kc1 kc2 b xL xH yL yH [c d1...dk]1 ... [c d1...dk]b

[Code] <1D>H<28>H<4C>H<pL><pH><m><fn><a><kc1><kc2>
<xL><xH><yL><yH>[c d1...dk]1...[c d1...dk]b

[Range] Parameter of GS (L
 $12 \leq (pL + pH \times 256) \leq 65535$ ($0 \leq pL \leq 255$, $0 \leq pH \leq 255$)
 Parameter of GS 8 L
 $12 \leq (p1 + p2 \times 256 + p3 \times 65536 + p4 \times 16777216) \leq 4294967295$
 ($0 \leq p1 \leq 255$, $0 \leq p2 \leq 255$, $0 \leq p3 \leq 255$, $0 \leq p4 \leq 255$)
 Common parameter of GS (L, GS 8 L
 m=48
 fn=67
 $32 \leq kc1 \leq 126$
 $32 \leq kc2 \leq 126$
 b=1, 2
 $1 \leq (xL + xH \times 256) \leq 8192$
 $1 \leq (yL + yH \times 256) \leq 2304$
 c=49 (When monochrome color paper is specified)
 c=49, 50 (When 2-color paper is specified)
 $0 \leq d \leq 255$
 $k = (\text{int}((xL + xH \times 256) + 7/8) \times (yL + yH \times 256))$
 All defined areas can be specified by GS (E from [0, 64K, 128K, 192K, 256K, 320K, 384K] bytes. Default value is 384K bytes.

[Outline] Defines raster type graphics data to NV memory.

- "b" specifies the number of data colors.
- xL, xH specifies the horizontal direction of defined data to $(xL + xH \times 256)$.
- yL, yH specifies the vertical direction of defined data to $(yL + yH \times 256)$.
- "c" specifies the color of defined data.

c	Color of Defined Data
49	1st color
50	2nd color

- 1st color denotes black (high energy) in the specified 2-color thermal paper.
- 2nd color denotes red (low energy) in the specified 2-color thermal paper.

[Caution] When multiple colors is specified by "b" and the same color is selected by "c", the command processing is terminated at that point, validating the defined data processed so far and the remaining data is read and discarded.

fn = 69: Function 69 Printing Specified Graphics

GS (L pL pH m fn kc1 kc2 x y

[Code] <1D>H<28>H<4C>H<pL><pH><m><fn><kc1><kc2><x><y>

[Range] $(pL + pH \times 256) = 6$ ($pL = 6, pH = 0$)
m=48
fn=69
 $32 \leq kc1 \leq 126$
 $32 \leq kc2 \leq 126$
x=1, 2
y=1, 2

[Outline] Prints the NV graphics data defined by key code (kc1, kc2) as large as x times horizontally/y times vertically.

fn = 112: Function 112 Storing Raster Type Graphics Data to Print Buffer

GS (L pL pH m fn a bx by c xL xH yL yH d1...dk

[Code] <1D>H<28>H<4C>H<pL><pH><m><fn><a><bx><by><c><xL><xH><yL><yH>[d1...dk]

[Range] Parameter of GS (L
 $11 \leq (pL + pH \times 256) \leq 65536$ ($0 \leq pL \leq 255, 0 \leq pH \leq 255$)
 Parameter of GS 8 L
 $11 \leq (p1 + p2 \times 256) + p3 \times 65536 + p4 \times 16777216 \leq 4294967295$
 ($0 \leq p1 \leq 255, 0 \leq p2 \leq 255, 0 \leq p3 \leq 255, 0 \leq p4 \leq 255$)
 Common parameter of GS (L, GS 8 L
 m=48
 fn=112
 a=48
 bx=1, 2
 by=1, 2
 c=49 (When monochrome color paper is specified)
 c=49, 50 (When 2-color paper is specified)
 $1 \leq (xL + xH \times 256) \leq 1024$
 When monochrome color paper is specified
 $1 \leq (yL + yH \times 256) \leq 1662$ (with by = 1)
 $1(yLyH \times 256) \leq 831$ (with by = 2)
 When 2-color paper is specified
 $1 \leq (yL + yH \times 256) \leq 831$ (with by = 1)
 $1 \leq (yL + yH \times 256) \leq 415$ (with by = 2)
 $0 \leq d \leq 255$
 $k = (\text{int}((xL + xH \times 256) + 7/8) \times (yL + yH \times 256))$

[Outline] Stores raster type graphics data to print buffer as large as x times horizontally/y times vertically.

- xL, xH specifies the horizontal direction of raster graphics data to (xL+xH×256).
- yL, yH specifies the vertical direction of raster graphics data to (yL+yH×256).
- "c" specifies the color of print data.

c	Color of Print Data
49	1st color
50	2nd color

- 1st color denotes black (high energy) in the specified 2-color thermal paper.
- 2nd color denotes red (low energy) in the specified 2-color thermal paper.

[Caution] In STANDARD MODE, each color can be defined only once.

GS C 0 n m

[Function] Setting counter print mode

[Code] <1D>H<43>H<30>H<n><m>

[Range] $0 \leq n \leq 5$
 $0 \leq m \leq 2, 48 \leq m \leq 50$

[Outline] "n" sets the number of print columns for serial counter.

- n = 0 sets the actual counter to the number of print columns.
- n ≠ 0 sets the print columns to "n" columns.

"m" specifies the serial counter layout and data processing when the specified number of columns is not reached.

m	Print Position	Processing when Counter Does Not Reach Specified Number of Digits
0,48	Right-justified	Space is added to the left.
1,49	Right-justified	"0" is added to the left.
2,50	Left-justified	Space is added to the right.

[Default] n=0, m=0

GS C 1 aL aH bL bH n r

[Function] Setting counter mode (A)

[Code] <1D>H<43>H<31>H<aL><aH><bL><bH><n><r>

[Range] $0 \leq (aL + aH \times 256) \leq 65535$ ($0 \leq aL \leq 255, 0 \leq aH \leq 255$)
 $0 \leq (bL + bH \times 256) \leq 65535$ ($0 \leq bL \leq 255, 0 \leq bH \leq 255$)
 $0 \leq n \leq 255$
 $0 \leq r \leq 255$

[Outline] Sets the count mode of serial counter in number.

- aL, aH, bL, bH specifies the counting range of serial counter.
- "n" specifies the number of steps when serial counter is reset.
- "r" specifies the times of repetition with counting value fixed.

Count Mode	Condition	Min.	Max.
Count up	$(aL + aH \times 256) < (bL + bH \times 256)$ and $n \neq 0$ and $r \neq 0$	$aL + aH \times 256$	$bL + bH \times 256$
Count down	$(aL + aH \times 256) > (bL + bH \times 256)$ and $n \neq 0$ and $r \neq 0$	$bL + bH \times 256$	$aL + aH \times 256$
Count stop	$(aL + aH \times 256) = (bL + bH \times 256)$ or $n = 0$ or $r = 0$	—	—

[Default] $(aL + aH \times 256) = 1$ ($aL = 1, aH = 0$)
 $(bL + bH \times 256) = 65535$ ($bL = 255, bH = 255$)
 $n = 1, r = 1$

GS C 2 nL nH

[Function] Setting counter value

[Code] <1D>H<43>H<32>H<nL><nH>

[Range] $0 \leq (nL + nH \times 256) \leq 65535$ ($0 \leq nL \leq 255, 0 \leq nH \leq 255$)

[Outline] Sets the count value of serial counter to $(nL + nH \times 256)$.

[Default] $(nL + nH \times 256) = 1$ ($nL = 1, nH = 0$)

GS C ; sa ; sb ; sn ; sr ; sc ;

[Function] Setting count mode (B)

[Code] <1D>H<43>H<3B>H<sa><3B>H<sb><3B>H<sn><3B>H<sr><3B>H<sc><3B>H

[Range] $0 \leq sa \leq 65535$, $0 \leq sb \leq 65535$
 $0 \leq sn \leq 255$, $0 \leq sr \leq 255$
 $0 \leq sc \leq 65535$

[Outline] Sets the count mode and counter value of serial counter in character row.

- "sa", "sb" specifies the counting range of serial counter.
- "sr" specifies the number of repetition with count value fixed.
- "sn" specifies the number of steps when serial counter is reset.
- "sc" specifies the counting value of serial counter.

Count Mode	Condition	Max.	Min.
Count up	sa < sb and sn ≠ 0 and sr ≠ 0	sa	sb
Count down	sa > sb and sn ≠ 0 and sr ≠ 0	sb	sa
Count stop	sa = sb or sn = 0 or sr = 0	—	—

[Default] sa=1, sb=65535, sn=1, sr=1, sc=1

GS c

[Function] Print the counter

[Code] <1D>H<63>H

[Outline] Stores the count value of serial counter to the print buffer as print data.

- Executes resetting of counter value after storage.

3. CHARACTER CODE TABLE

3.1 Code Page

3.1.1 Code page 00H to 7FH & PC437 (USA, Europe Standard)

	0	1	2	3	4	5	6	7	8	9	A	B	C	D	E	F
0	NUL	DLE		0	@	P	`	p	Ç	É	á	☒	⊥	⊥	α	≡
1		XON	!	1	A	Q	a	q	ü	æ	í	☒	⊥	⊥	β	±
2			”	2	B	R	b	r	é	Æ	ó	☒	⊥	⊥	Γ	≧
3		XOFF	#	3	C	S	c	s	â	ô	ú		⊥	⊥	π	≦
4	EOT	DC4	\$	4	D	T	d	t	ä	ö	ñ	⊥	—	⊥	Σ	∫
5	ENQ		%	5	E	U	e	u	à	ò	Ñ	⊥	+	⊥	σ	∫
6			&	6	F	V	f	v	â	û	á	⊥	⊥	⊥	μ	÷
7			'	7	G	W	g	w	ç	ù	ó	⊥	⊥	⊥	τ	≈
8		CAN	(8	H	X	h	x	ê	ÿ	¿	⊥	⊥	⊥	Φ	°
9	HT)	9	I	Y	i	y	ë	ö	¬	⊥	⊥	⊥	θ	
A	LF		*	:	J	Z	j	z	è	Ü	¬		⊥	⊥	Ω	·
B		ESC	+	;	K	[k	{	ï	œ	½	⊥	⊥	■	δ	√
C	FF	FS	,	<	L	¥	l		î	&	¼	⊥	⊥	■	∞	ⁿ
D	CR	GS	-	=	M]	m	}	ì	¥	i	⊥	=	■	∅	²
E		RS	.	>	N	^	n	~	Ä	Pt	«	⊥	⊥	■	€	■
F			/	?	O	_	o		Å	f	»	⊥	⊥	■	∩	

3.1.2 Code page 00H to 7FH & Katakana

	0	1	2	3	4	5	6	7	8	9	A	B	C	D	E	F
0	NUL	DLE		0	@	P	`	p	_	⊥	SP	ー	タ	ミ	=	×
1		XON	!	1	A	Q	a	q	■	⊥	°	ア	チ	ム	ト	円
2			”	2	B	R	b	r	■	⊥	⌒	イ	ツ	メ	+	年
3		XOFF	#	3	C	S	c	s	■	⊥	┘	ウ	テ	モ	⊥	月
4	EOT	DC4	\$	4	D	T	d	t	■	—	、	エ	ト	ヤ	◀	日
5	ENQ		%	5	E	U	e	u	■	—	・	オ	ナ	ユ	▶	時
6			&	6	F	V	f	v	■		ヲ	カ	ニ	ヨ	▼	分
7			'	7	G	W	g	w	■		ア	キ	ヌ	ラ	▼	秒
8		CAN	(8	H	X	h	x		⌒	イ	ク	ネ	リ	♠	〒
9	HT)	9	I	Y	i	y		⌒	ウ	ケ	ノ	ル	♥	市
A	LF		*	:	J	Z	j	z		┘	エ	コ	ハ	レ	◆	区
B		ESC	+	;	K	[k	{	■	┘	オ	サ	ヒ	ロ	♣	町
C	FF	FS	,	<	L	¥	l		■	⌒	ヤ	シ	フ	ワ	●	村
D	CR	GS	-	=	M]	m	}	■	⌒	ユ	ス	ヘ	ン	○	人
E		RS	.	>	N	^	n	~	■	⌒	ヨ	セ	ホ	“	/	☎
F			/	?	O	_	o		+	⌒	ツ	ソ	マ	°	\	

3.1.3 Code page 00H to 7FH & PC850 (Multilingual)

	0	1	2	3	4	5	6	7	8	9	A	B	C	D	E	F
0	NUL	DLE		0	@	P	`	p	Ç	É	á	☒	⌒	đ	ó	—
1		XON	!	1	A	Q	a	q	ü	æ	í	☒	⊥	Đ	β	±
2			”	2	B	R	b	r	é	Æ	ó	☒	⊥	Ê	Ô	=
3		XOFF	#	3	C	S	c	s	â	ô	ú		⊥	Ë	Ò	¾
4	EOT	DC4	\$	4	D	T	d	t	ä	ö	ñ	⊥	—	È	õ	¶
5	ENQ		%	5	E	U	e	u	à	ò	Ñ	Á	+	·	Õ	§
6			&	6	F	V	f	v	å	û	<u>a</u>	Â	ã	í	μ	÷
7			'	7	G	W	g	w	ç	ù	<u>o</u>	À	Ã	î	þ	,
8		CAN	(8	H	X	h	x	ê	ÿ	ı	©	⌒	ï	þ	°
9	HT)	9	I	Y	i	y	ë	ÿ	®	⊥	⌒	⌒	Ú	”
A	LF		*	:	J	Z	j	z	è	Ü	¬		⊥	⌒	Û	·
B		ESC	+	;	K	[k	{	ï	ø	½	⌒	⊥	■	Ù	¹
C	FF	FS	,	<	L	¥	l		î	£	¼	⌒	⊥	■	Ý	³
D	CR	GS	-	=	M]	m	}	ì	Ø	i	œ	-	ı	Ý	²
E		RS	.	>	N	^	n	~	Ä	×	«	¥	⊥	ı	—	■
F			/	?	O	_	o		Å	f	»	⌒	⊗	■	'	

3.1.4 Code page 00H to 7FH & PC860 (Portuguese)

	0	1	2	3	4	5	6	7	8	9	A	B	C	D	E	F
0	NUL	DLE		0	@	P	`	p	Ç	É	á	☒	┌	⊥	α	≡
1		XON	!	1	A	Q	a	q	ü	À	í	☒	┌	┐	β	±
2			”	2	B	R	b	r	é	È	ó	☒	┐	┐	Γ	≥
3		XOFF	#	3	C	S	c	s	â	ô	ú		┐	┌	π	≤
4	EOT	DC4	\$	4	D	T	d	t	ã	õ	ñ	┐	—	┌	Σ	∫
5	ENQ		%	5	E	U	e	u	à	ò	Ñ	┐	+	┐	σ	∫
6			&	6	F	V	f	v	Á	Ú	<u>a</u>	┐	┐	┐	μ	÷
7			'	7	G	W	g	w	ç	ù	<u>o</u>	┐	┐	┐	τ	≈
8		CAN	(8	H	X	h	x	ê	ì	¿	┐	┌	+	Φ	°
9	HT)	9	I	Y	i	y	Ê	Õ	Ò	┐	┐	┐	θ	
A	LF		*	:	J	Z	j	z	è	Ü	¬		┌	┐	Ω	·
B		ESC	+	;	K	[k	{	Í	ø	½	┐	┐	■	δ	√
C	FF	FS	,	<	L	¥	l		Ô	£	¼	┐	┐	■	∞	ⁿ
D	CR	GS	-	=	M]	m	}	ì	Ù	i	┐	—	■	∅	₂
E		RS	.	>	N	^	n	~	Ã	Pt	«	┐	┐	■	€	■
F			/	?	O	_	o		Â	Ó	»	┐	┌	■	∩	

3.1.5 Code page 00H to 7FH & PC863 (Canadian-French)

	0	1	2	3	4	5	6	7	8	9	A	B	C	D	E	F
0	NUL	DLE		0	@	P	`	p	Ç	É	ı	☒	┌	⊥	α	≡
1		XON	!	1	A	Q	a	q	ü	È	´	☒	┌	┐	β	±
2			”	2	B	R	b	r	é	Ê	ó	☒	┐	┐	Γ	≥
3		XOFF	#	3	C	S	c	s	â	ô	ú		┐	┌	π	≤
4	EOT	DC4	\$	4	D	T	d	t	Â	Ë	”	┐	—	┌	Σ	∫
5	ENQ		%	5	E	U	e	u	à	ï	,	┐	+	┐	σ	∫
6			&	6	F	V	f	v	¶	û	°	┐	┐	┐	μ	÷
7			'	7	G	W	g	w	ç	ù	-	┐	┐	┐	τ	≈
8		CAN	(8	H	X	h	x	ê	ø	î	┐	┌	+	Φ	◦
9	HT)	9	I	Y	i	y	ë	ô	¬	┐	┐	┐	θ	
A	LF		*	:	J	Z	j	z	è	Ü	¬		┌	┐	Ω	·
B		ESC	+	;	K	[k	{	ï	ø	½	┐	┐	■	δ	√
C	FF	FS	,	<	L	¥	l		î	£	¼	┐	┐	■	∞	ⁿ
D	CR	GS	-	=	M]	m	}	=	Ù	¾	┐	-	■	∅	²
E		RS	.	>	N	^	n	~	À	Ò	«	┐	┐	■	€	■
F			/	?	O	_	o		§	f	»	┐	┌	■	∩	

3.1.6 Code page 00H to 7FH & PC865 (Nordic)

	0	1	2	3	4	5	6	7	8	9	A	B	C	D	E	F
0	NUL	DLE		0	@	P	`	p	Ç	É	á	☒	┌	⊥	α	≡
1		XON	!	1	A	Q	a	q	ü	æ	í	☒	┌	└	β	±
2			”	2	B	R	b	r	é	Æ	ó	☒	└	└	Γ	≧
3		XOFF	#	3	C	S	c	s	â	ô	ú		└	┌	π	≦
4	EOT	DC4	\$	4	D	T	d	t	ä	ö	ñ	└	—	┌	Σ	∫
5	ENQ		%	5	E	U	e	u	à	ò	Ñ	└	+	└	σ	∫
6			&	6	F	V	f	v	å	û	<u>a</u>	└	└	└	μ	÷
7			'	7	G	W	g	w	ç	ù	<u>o</u>	└	└	└	τ	≈
8		CAN	(8	H	X	h	x	ê	ÿ	ı	└	┌	+	Φ	◦
9	HT)	9	I	Y	i	y	ë	ö	ı	└	└	└	θ	
A	LF		*	:	J	Z	j	z	è	Ü	ı		┌	└	Ω	·
B		ESC	+	;	K	[k	{	ï	ø	½	└	└	■	δ	√
C	FF	FS	,	<	L	¥	l		î	£	¼	└	└	■	∞	ⁿ
D	CR	GS	-	=	M]	m	}	ì	Ø	i	└	—	■	∅	₂
E		RS	.	>	N	^	n	~	Ä	Pt	«	└	└	■	€	■
F			/	?	O	_	o		Å	f	◊	└	┌	■	∩	

3.1.7 Code page 00H to 7FH & PC852 (Eastern Europe)

	0	1	2	3	4	5	6	7	8	9	A	B	C	D	E	F
0	NUL	DLE		0	@	P	`	p	Ç	É	á	☒	⌒	đ	ó	-
1		XON	!	1	A	Q	a	q	ü	Í	í	☒	⊥	Đ	β	”
2			”	2	B	R	b	r	é	í	ó	☒	⊥	Ď	ô	,
3		XOFF	#	3	C	S	c	s	â	ô	ú		⊥	Ě	Ń	˘
4	EOT	DC4	\$	4	D	T	d	t	ä	ö	À	⊥	—	d'	ñ	˘
5	ENQ		%	5	E	U	e	u	û	Ł	ą	Á	+	Ń	ñ	§
6			&	6	F	V	f	v	ć	ł	ż	Â	Ă	í	š	÷
7			'	7	G	W	g	w	ç	ś	ż	Ě	ă	î	š	,
8		CAN	(8	H	X	h	x	ł	ś	Ę	Ş	⌒	ě	Ŕ	°
9	HT)	9	I	Y	i	y	ë	ö	ę	⊥	⌒	⌒	ú	”
A	LF		*	:	J	Z	j	z	ő	ü			⊥	⌒	ř	.
B		ESC	+	;	K	[k	{	õ	ř	z	⌒	⊥	■	Ú	ú
C	FF	FS	,	<	L	¥	l		î	ř	č	⌒	⊥	■	ý	Ř
D	CR	GS	-	=	M]	m	}	ž	ł	ş	Ž	-	⊥	Ý	ř
E		RS	.	>	N	^	n	~	Ä	×	«	z	⊥	Ů	ț	■
F			/	?	O	_	o		Ć	č	»	⌒	⊥	■	'	

3.1.8 Code page 00H to 7FH & PC866 (Russian)

	0	1	2	3	4	5	6	7	8	9	A	B	C	D	E	F
0	NUL	DLE		0	@	P	`	p	А	Р	а	⌘	⌘	⌘	р	Ё
1		XON	!	1	A	Q	a	q	Б	С	б	⌘	⌘	⌘	с	ё
2			“	2	B	R	b	r	В	Т	в	⌘	⌘	⌘	т	ε
3		XOFF	#	3	C	S	c	s	Г	У	г		⌘	⌘	у	ε
4	EOT	DC4	\$	4	D	T	d	t	Д	Ф	д	⌘	—	⌘	ф	ї
5	ENQ		%	5	E	U	e	u	Е	Х	е	⌘	⌘	⌘	х	ї
6			&	6	F	V	f	v	Ж	Ц	ж	⌘	⌘	⌘	ц	ў
7			'	7	G	W	g	w	З	Ч	з	⌘	⌘	⌘	ч	ў
8		CAN	(8	H	X	h	x	И	Ш	и	⌘	⌘	⌘	ш	°
9	HT)	9	I	Y	i	y	Й	Щ	й	⌘	⌘	⌘	щ	·
A	LF		*	:	J	Z	j	z	К	Ъ	к		⌘	⌘	ъ	·
B		ESC	+	;	K	[k	{	Л	Ы	л	⌘	⌘	■	ы	√
C	FF	FS	,	<	L	¥	l		М	Ь	м	⌘	⌘	■	ь	No .
D	CR	GS	-	=	M]	m	}	Н	Э	н	⌘	—	■	э	⊗
E		RS	.	>	N	^	n	~	О	Ю	о	⌘	⌘	■	ю	■
F			/	?	0	_	o		П	Я	п	⌘	⌘	■	я	

3.1.9 Code page 00H to 7FH & PC857(Turkish)

	0	1	2	3	4	5	6	7	8	9	A	B	C	D	E	F
0	NUL	DLE		0	@	P	`	p	Ç	É	á	☒	⌒	o	ó	—
1		XON	!	1	A	Q	a	q	ü	æ	í	☒	⊥	a	β	±
2			”	2	B	R	b	r	é	Æ	ó	☒	⊥	Ê	ô	
3		XOFF	#	3	C	S	c	s	â	ô	ú		⊥	Ë	ò	¼
4	EOT	DC4	\$	4	D	T	d	t	ä	ö	ñ	⊥	—	È	õ	¶
5	ENQ		%	5	E	U	e	u	à	ò	Ñ	Á	+		Õ	§
6			&	6	F	V	f	v	â	û	ğ	Â	ã	í	μ	÷
7			'	7	G	W	g	w	ç	ù	ğ	À	Ã	î		,
8		CAN	(8	H	X	h	x	ê	í	ı	©	⌒	ï	×	°
9	HT)	9	I	Y	i	y	ë	Ö	®	⊥	⌒	⊥	Ú	”
A	LF		*	:	J	Z	j	z	è	Ü	¬		⊥	⌒	Û	.
B		ESC	+	;	K	[k	{	ï	ø	½	⌒	⊥	■	Ù	'
C	FF	FS	,	<	L	¥	l		î	£	¼	⌒	⊥	■	ì	³
D	CR	GS	-	=	M]	m	}	ı	Ø	i	œ	-		ÿ	²
E		RS	.	>	N	^	n	~	Ä	Ş	«	¥	⊥	ì	-	■
F			/	?	O	_	o		Å	ş	»	⌒	⊗	■	'	

3.1.10 Code page 00H to 7FH & PC864 (Arabic)

	0	1	2	3	4	5	6	7	8	9	A	B	C	D	E	F
0	NUL	DLE		0	@	P	`	p	◦	β	(RSP)	•	¢	ذ	ـ	ء
1		XON	!	1	A	Q	a	q	•	∞	(SHY)	۱	ء	ر	ف	ة
2			”	2	B	R	b	r	•	φ	آ	۲	آ	ز	ق	ن
3		XOFF	#	3	C	S	c	s	√	±	£	۳	أ	س	ك	ه
4	EOT	DC4	\$	4	D	T	d	t	■	½	⊗	۴	ؤ	ش	ل	ف
5	ENQ		%	5	E	U	e	u	▢	¼	ل	۵	ع	ص	د	ي
6			&	6	F	V	f	v	▣	≈		۶	ك	ض	ن	ي
7			'	7	G	W	g	w	▤	«		۷	ا	ط	ه	غ
8		CAN	(8	H	X	h	x	▥	»	ا	۸	ب	ظ	و	ق
9	HT)	9	I	Y	i	y	▦	لأ	ب	۹	ة	ع	ي	لأ
A	LF		*	:	J	Z	j	z	▧	لأ	ت	ف	ت	غ	ي	لأ
B		ESC	+	;	K	[k	{	▨		ث	:	ث	ا	ض	ل
C	FF	FS	,	<	L	\	l		▩		،	س	ج	ـ	ع	ك
D	CR	GS	-	=	M]	m	}	▪	لا	ج	ش	ج	÷	غ	ي
E		RS	.	>	N	^	n	~	▫	لا	ح	ص	خ	×	غ	■
F			/	?	O	_	o		▬	،	خ	؟	د	ع	م	

3.1.11 Code page 00H to 7FH & Windows Code page

	0	1	2	3	4	5	6	7	8	9	A	B	C	D	E	F
0	NUL	DLE		0	@	P	`	p	.			°	À	Đ	à	đ
1		XON	!	1	A	Q	a	q		'	i	±	Á	Ñ	á	ñ
2			”	2	B	R	b	r	,	'	ç	²	Â	Ò	â	ò
3		XOFF	#	3	C	S	c	s	f	“	£	³	Ã	Ó	ã	ó
4	EOT	DC4	\$	4	D	T	d	t	,,	”	¤	´	Ä	Ô	ä	ô
5	ENQ		%	5	E	U	e	u	¥	µ	Å	Õ	å	õ
6			&	6	F	V	f	v	†	-	¡	¶	Æ	Ö	æ	ö
7			'	7	G	W	g	w	‡	-	§	.	Ç	×	ç	÷
8		CAN	(8	H	X	h	x	^	~	¨	,	È	Ø	è	ø
9	HT)	9	I	Y	i	y	%o	™	©	¹	É	Ù	é	ù
A	LF		*	:	J	Z	j	z	Š	š	ª	º	Ê	Ú	ê	ú
B		ESC	+	;	K	[k	{	<	>	«	»	Ë	Û	ë	û
C	FF	FS	,	<	L	¥	l		Œ	œ	¬	¼	Ì	Ü	ì	ü
D	CR	GS	-	=	M]	m	}			-	½	Í	Ý	í	ý
E		RS	.	>	N	^	n	~	Ž	ž	®	¾	Î	Þ	î	þ
F			/	?	O	_	o			ÿ	-	¿	Ï	ß	ï	ÿ

3.2 International Character Code Table

	Country	23	24	40	5B	5C	5D	5E	60	7B	7C	7D	7E
0	U.S.A	#	\$	@	[\]	^	'	{		}	~
1	France	#	\$	à	°	ç	§	^	'	é	ù	è	¨
2	Germany	#	\$	§	Ä	Ö	Ü	^	'	ä	ö	ü	β
3	U.K.	&	\$	@	[\]	^	'	{		}	~
4	Denmark I	#	\$	@	Æ	Ø	Å	^	'	æ	ø	å	~
5	Sweden	#	¤	É	Ä	Ö	Å	Ü	é	ä	ö	å	ü
6	Italy	#	\$	@	°	\	é	^	ù	à	ò	è	ì
7	Spain I	Pt	\$	@	í	Ñ	¿	^	'	¨	ñ	}	~
8	Japan	#	\$	@	[¥]	^	'	{		}	~
9	Norway	#	¤	É	Æ	Ø	Å	Ü	é	æ	ø	å	ü
10	Denmark II	#	\$	É	Æ	Ø	Å	Ü	é	æ	ø	å	ü
11	Spain II	#	\$	á	í	Ñ	¿	é	'	ì	ñ	ó	ú
12	Latin America	#	\$	á	í	Ñ	¿	é	ü	ì	ñ	ó	ú
13	Korea	#	\$	@	[₩]	^	'	{		}	~

4. APPENDIX

4.1 Explanation on PAGE MODE

4.1.1 Overview

The printer has two print modes: STANDARD and PAGE.

In STANDARD MODE, the printer prints or feeds paper each time it receives a print or paper feed command. In PAGE MODE, when the printer receives print commands and/or form feed commands, it simply forwards them to the specified print area of memory. Only when an ESC FF or FF is executed, all the data mapped in the print area will then be printed in a batch.

For example, suppose you executed a print and line feed for data "ABCDEF"<LF>. In STANDARD MODE, the data "ABCDEF" is printed and paper is advanced one line. In PAGE MODE, the data "ABCDEF" is written in the specified print area of memory, and the memory location for the storage of the next print data is shifted one line.

The printer enters PAGE MODE with an ESC L, so that all commands received after that point are handled in PAGE MODE. When an ESC FF is executed, the data received until then is printed in a batch. When an FF is executed, the data received until then is printed in a batch, after which the printer returns to STANDARD MODE. An ESC S causes the printer to immediately return to STANDARD MODE; any print data, however, that has been stored in PAGE MODE is not printed. Instead it will be cleared.

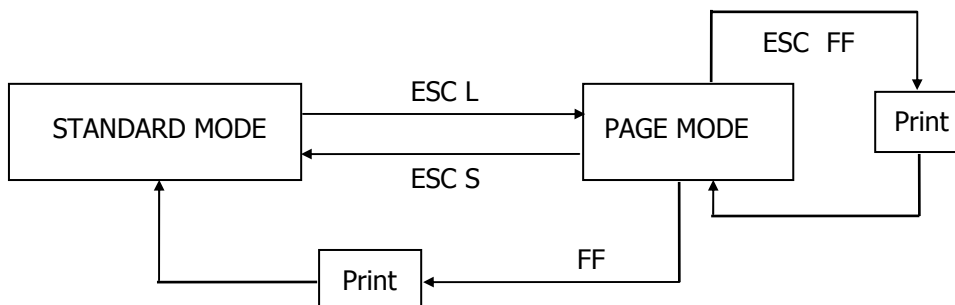

[Switching Between STANDARD MODE and PAGE MODE]

4.1.2 Values Set by Each Command in STANDARD MODE and PAGE MODE

(1) The values set with commands are common to the STANDARD MODE and PAGE MODE. The values set with any of the commands listed below are, however, treated differently and stored separately for the STANDARD and PAGE MODES.

- ESC SP, ESC 2, ESC 3, FS S

(2) The maximum printable size of a bitmap image is 576 dots for STANDARD MODE. In PAGE MODE, the maximum printable size of a bitmap image is 831 dots in the "y" direction (paper feed direction).

(However 831 dots are reserved for "y" of the print area set by ESC W and the value of print direction "n" specified by ESC T is 1 or 3.)

4.1.3 Mapping of Print Data in the Print Area

Print data is mapped in the print area as follows:

- (1) The print area is set by ESC W. When the printer has finished all of the print and paper feed actions specified before receiving an ESC W, the ESC W sets the right end (as viewed facing the printer) as the start point (x0, y0) of the print area. The print area is a rectangle defined by two edges extending from the start point (x0, y0): one edge running in the "x" (Horizontal) direction by "dx" pitch (inclusive of the start point), and the other running in the "y" (Vertical) direction by "dy" pitch. (If no ESC W is defined, the default values are used to define the print area.)
- (2) With a print area defined by ESC W and a print direction specified by ESC T, when the printer receives print data, the print data is mapped in the print area where point A (see the Figure 4-1 "Mapping Position for Character Data") is used as the initial value of the start point. If the print data consists of characters, this start point serves as the baseline. If the print data is a downloaded bitmap image or a bar code, the print data is mapped with its lower-left point B aligned to the baseline. (See the Figure 4-2 "Mapping Positions for Print Data".) When attempting to map the HRI characters of a bar code, however, the section above the standard character height will not be printed.
- (3) If print data (or the space to the right of a character) extends beyond the print area before a command that involves a line feed (for example, LF or ESC J command) is received, a line feed is automatically executed in the print area, so that the mapping position of the print data is moved one line. The next mapping position will be the beginning of the line. In this case, the line feed width is as defined by a command such as ESC 2 or ESC 3.
- (4) By default, the line feed width is 1/6 inch, which is equivalent to 34 dots. If the print data for the next line includes a vertically doubled or taller character, a downloaded bitmap image extending two or more lines, or a bar code taller than the character height, the data, therefore, falls short of the line feed width, causing the upper dots of the character to overlap the print data of the current line. The line feed width needs to be increased.

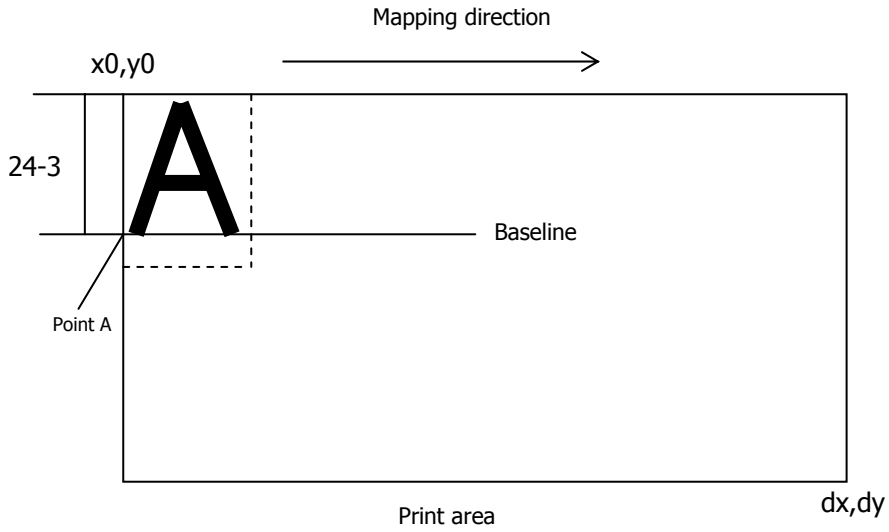

Figure 4-1 Mapping Position for Character Data

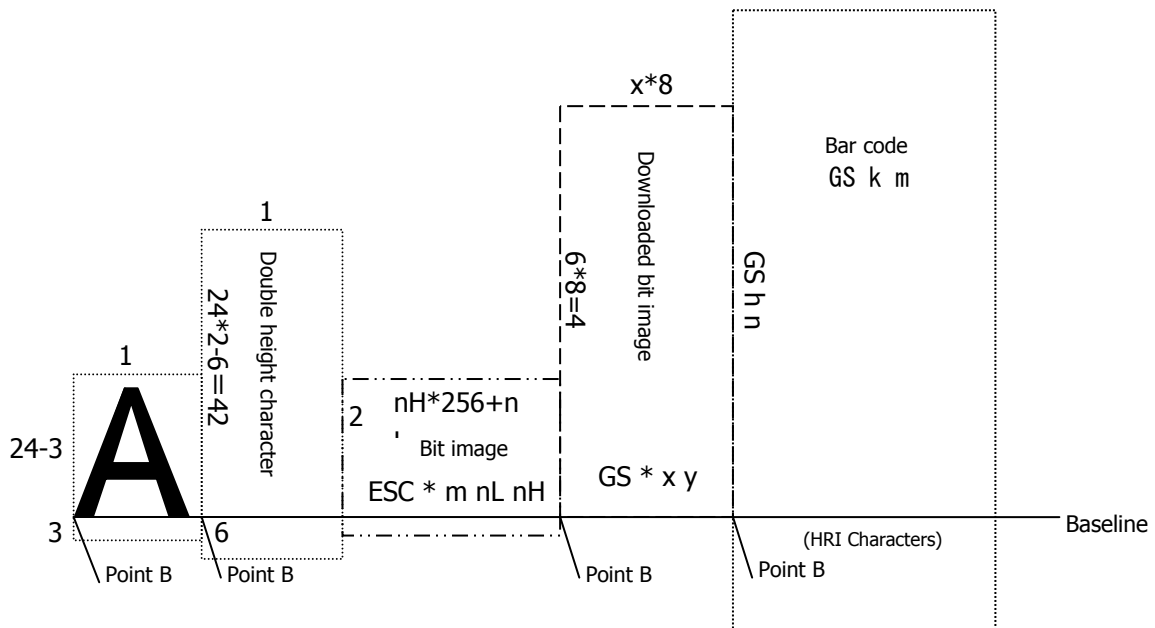

Figure 4-2 Mapping Positions for Print Data

4.1.4 Example of Using PAGE MODE

The following explains specific uses of PAGE MODE.

When in PAGE MODE, the commands are typically sent from the host to the printer in the following sequence:

- (1) An ESC L puts the printer in PAGE MODE.
- (2) An ESC W specifies the print area.
- (3) An ESC T specifies the print direction.
- (4) Print data is sent.
- (5) An FF instructs the printer to print the print data in a batch.
- (6) After printing, the printer returns to STANDARD MODE.

< Example 1 >

```
100 PRINT #1, CHR$(&H1B);"L";
110 PRINT #1, CHR$(&H1B);"W";CHR$(0);CHR$(0);CHR$(0);CHR$(0);
120 PRINT #1, CHR$(200);CHR$(0);CHR$(144);CHR$(1);
130 PRINT #1, CHR$(&H1B);"T";CHR$(0);
140 PRINT #1, "Page mode lesson Test1"
150 PRINT #1, CHR$(&HC);
```

The program in Example 1 reserves a print area of 200×400 pitches extending from the start point (0, 0), and then prints the text "Page Mode lesson Test 1" on the first line of the print area as shown in Figure 4-3 "Example 1: Results of Print".

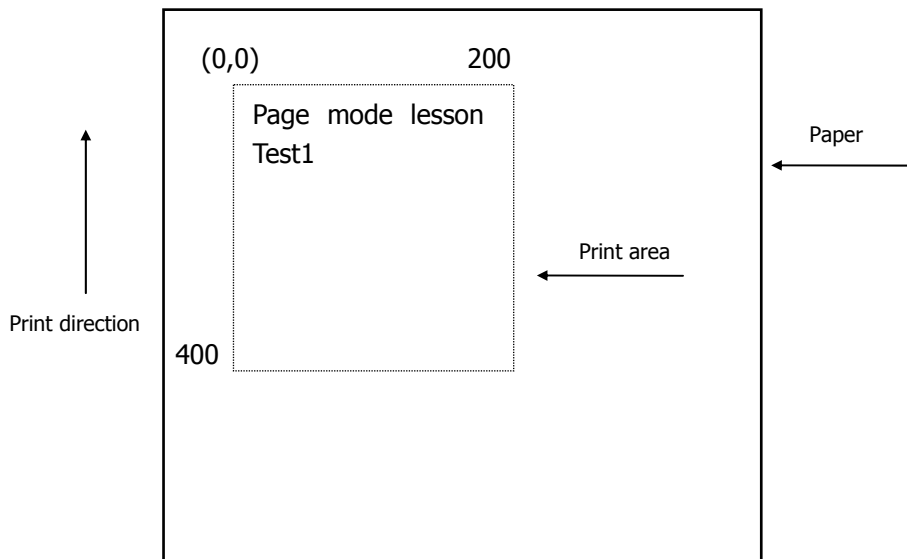

Figure 4-3 Example 1: Results of Print

In Figure 4-3, a line feed occurs between "lesson" and "Test 1" because the space " " next to "lesson" does not fit in the horizontal range of the 200×400-pitch print area. The line feed width conforms to the value specified by a command such as ESC 3.

It is possible to set as many print areas as desired before executing FF. If print areas overlap each other, the print area setup data are Ored with the previous data.

If you want to erase a section of mapped data, use the CAN command. The CAN command erases all data in the print area being specified. You can, therefore, use an ESC W to define a print area that encloses the section you want to erase, and then execute the CAN command, so that the section of the data is erased.

It is important to remember that any part of a character that overlaps with the specified print area will be erased.

< Example 2 >

```

100 PRINT #1, CHR$(&H1B);"L";
110 PRINT #1, CHR$(&H1B);"W";CHR$(0);CHR$(0);CHR$(0);CHR$(0);
120 PRINT #1, CHR$(200);CHR$(0);CHR$(144);CHR$(1);
130 PRINT #1, CHR$(&H1B);"T";CHR$(0);
140 PRINT #1, "Page mode lesson2CAN command";
150 PRINT #1, CHR$(&HA);
160 PRINT #1, "ABCDEFGHJKLMNOPQRST1234567890";
170 PRINT #1, CHR$(&HC);

```

First, an ESC L is sent to switch to PAGE MODE (100th line). Next, an ESC W is used to send eight arguments, n1 to n8, to reserve a print area. In this example, the arguments are sent in the sequence of 0, 0, 0, 0, 200, 0, 144, and 1, to reserve a print area that measures 200 from the start point (0, 0) in the "x" direction and 400 in the "y" direction (110th to 120th line). Furthermore, an ESC T is issued to specify the print direction to be "0" (130th line).

After the above setup, print data is sent (140th to 160th line). Finally, an FF is sent (170th line) to produce a print-out as shown in Figure 4-4 "Example 2: Result of Print".

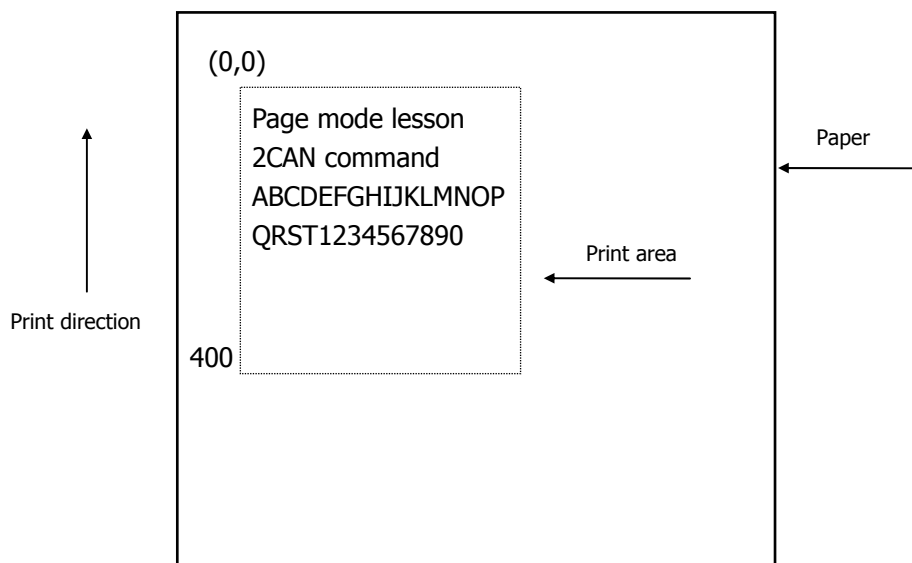

Figure 4-4 Example 2: Result of Print

Before an FF is sent (170th line), the following program code can be added to remove part of the data.

< Example 3 >

```
180 PRINT#1, CHR$(&H1B);"W"; CHR$(72); CHR$(0); CHR$(120); CHR$(0);  
190 PRINT#1, CHR$(36); CHR$(0); CHR$(48); CHR$(0);  
200 PRINT#1, CHR$(&H18);
```

As a result of the additional program code, a print-out is executed as shown in Figure 4-5 "Print Result of Adding a Program of Example 3 to Example 2", where the string "GHI" is removed. When strings are removed with CAN, the area where the string would have been is not used by the rest of the data; instead it is converted into a sequence of spaces.

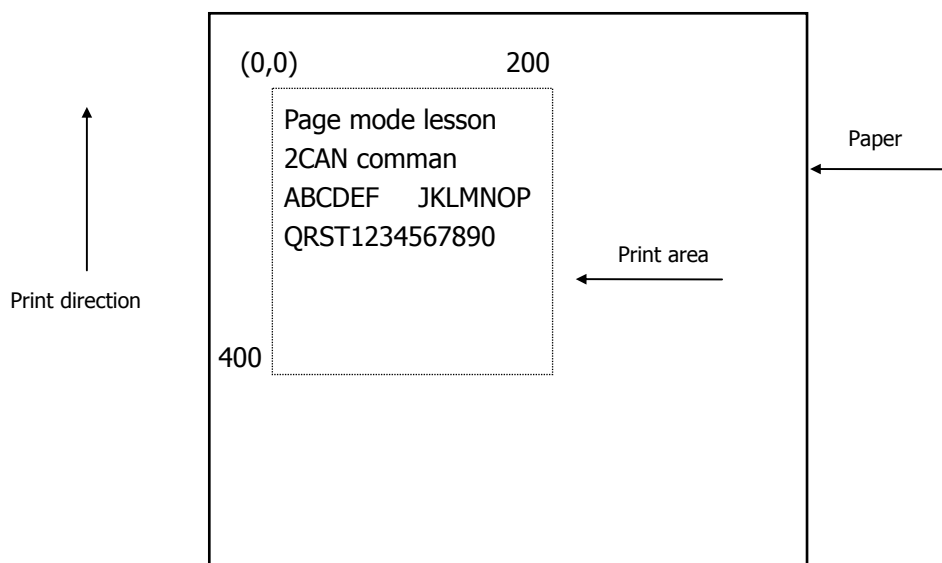

Figure 4-5 Print Result of Adding a Program of Example 3 to Example 2

4.2 Bidirectional Parallel Interface

Overview

The interface of the printer is a Level-1 compatible device according to IEEE-P1284. It supports the communication modes described in 4.2.1 below.

4.2.1 Parallel Interface Communication Mode

The parallel interface of the printer provides three communication modes as outlined below. When the printer is turned on or reset, it defaults to Compatibility mode.

- **Compatibility Mode**
Data is transmitted from the host to the printer in units of one byte. Usually, this mode is used for data transmission. You may switch to the other modes from Compatibility mode.
- **Nibble Mode**
Data is transmitted from the printer to the host in units of four bits. The data transmission from the printer uses a status signal line. To send one byte of data in this mode, two sets of four-bit data are sent consecutively.
- **Byte Mode**
Data is transmitted from the printer to the host in units of one byte. Data transmission from the printer uses an 8-bit data signal line. For Byte mode, the host must be capable of toggling the signal direction over the 8-bit data signal line. Communication from the host to the printer is called Forward mode, while communication from the printer to the host is called Reverse mode.

4.2.2 Interfacing Phases

Interfacing in each communication mode is divided into several phases. In addition, there is a phase for mode initialization, as well as a phase for mode switching. Interface signals may differ in name and function for different modes and different phases.

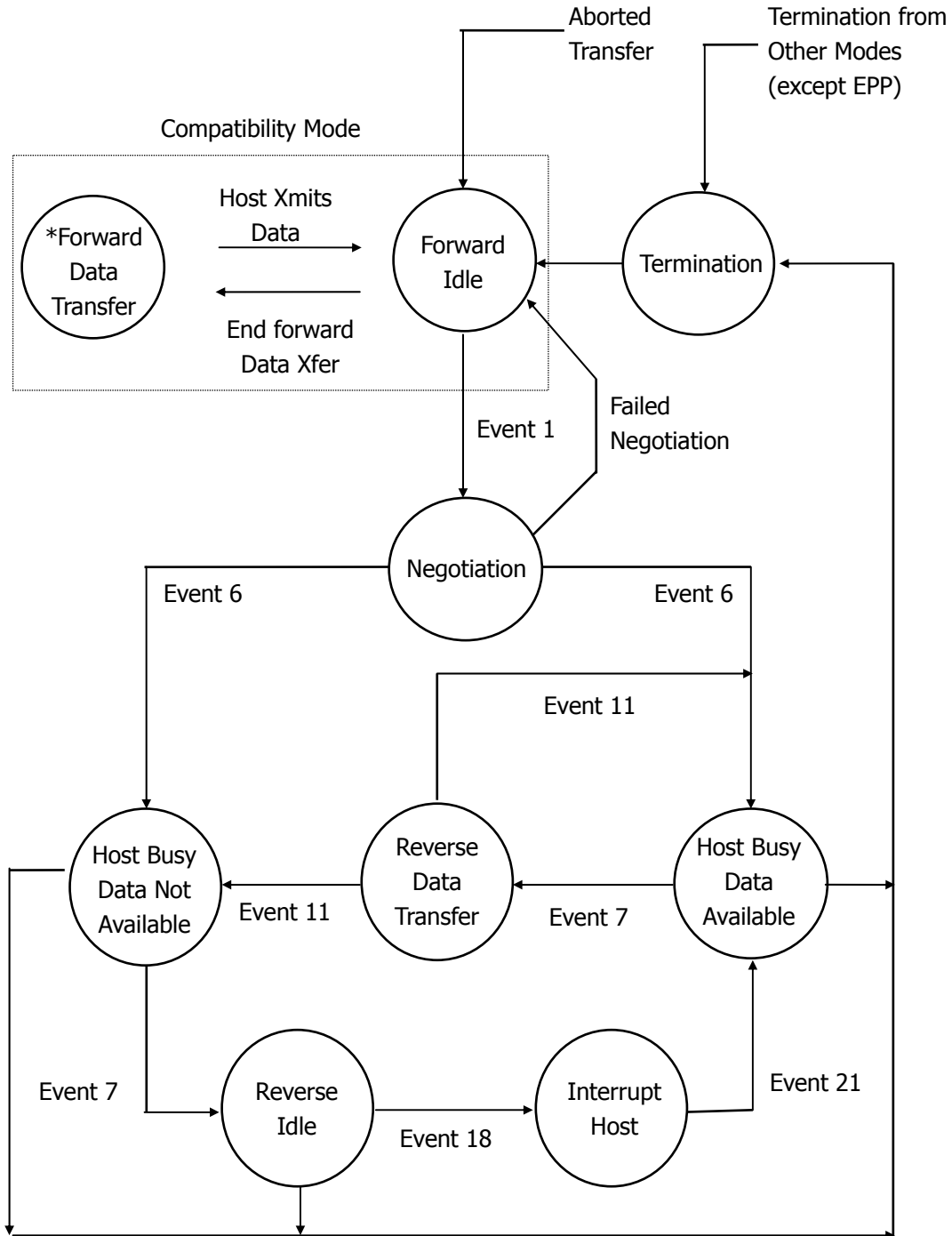

4.2.3 Negotiation

Overview

Usually, the printer is started in Compatibility mode, which corresponds to the Centronics interface phase.

When the host intends to switch to the Nibble or Byte mode, it sends a request and negotiates with the printer. A general flow of negotiations is given below.

- (1) The host sets the IEEE 1284 Active signal to High. In response, the printer moves into the Negotiation phase.
- (2) The printer replies whether it can execute the mode requested by the host.
- (3) The interface terminates the Negotiation phase and moves into the communication phase.

Negotiation Procedure

The negotiations proceed as follows:

- (1) In IEEE 1284 communication mode, the host and printer are in Compatibility mode by default. They remain in Compatibility mode as long as the host recognizes the connected device as an IEEE 1284 compatible device.
- (2) To start negotiations, the host sets the communication mode request bit on the data path. (Event 0)
- (3) The host sets IEEE 1284 Active (nSelectIn) to High, and HostBusy (nAutoFd) to Low. (Event 1)
- (4) The printer responds by setting PtrClk (nAck) to Low, nDataAvail (nFault) to High, Xflag (Select) to High, and AckDatReq (PError) to High. (Event 2)
- (5) The host sets HostClk (nStrobe) to Low. In response, the printer latches the data of the communication mode request bit. (Event 3)
- (6) The host sets HostClk (nStrobe) and HostBusy (nAutoFd) to High. (Event 4)
- (7) If the printer has communication data to send to the host, it sets AckDataReq (PError) to Low, nDataAvail (nFault) to Low, and Xflag (Select) to the value corresponding to the communication mode. (Event 5)
Xflag: Nibble Mode: Low
Byte Mode: High
- (8) The printer sets PtrClk (nAck) to High to indicate that it is ready to read status lines. (Event 6)
- (9) If the printer has communication data to send to the host, the host moves into the Host Busy Available phase or Termination phase, and then returns to the Compatibility mode.
- (10) If the printer has no communication data to send to the host, the host moves into the Host Busy Data Not Available phase or Termination phase, and then returns to the Compatibility mode.
- (11) If the printer cannot support the communication mode requested by the host, it sets Xflag (Select) as follows:
When Nibble mode is requested: High
When Byte mode is requested: Low

Precautions

- (1) The Negotiation phase is triggered when the IEEE 1284 Active signal sent by the host becomes High.
- (2) In Compatibility mode, the time when the negotiation process begins is, as a general rule, after the host sets nStrobe to High and then the printer outputs an nAck pulse.
Once the nStrobe signal is set to High, however, the printer immediately moves into the Negotiation phase when the high state of IEEE 1284 Active is detected, even if the nAck pulse has yet to be output or is being output. In this case, if the printer has returned to Compatibility mode after Termination, no nAck pulse will be output.
- (3) Negotiations can be entered from the Busy or Error state of the Compatibility mode. In this case, the printer will not return to the Busy or Error state before the negotiations, but still remains in the printer state just after Termination.
- (4) If the host requested a communication mode that is not supported by the printer, it must move into the Termination phase and return to the Compatibility mode.

Table 2.4.1 Definitions of Request Bits in IEEE 1284 Communication Mode

Bit	Definition	Bit Values (76543210)	Hex. Code	Xflag	
				When In the Supported	Printer
7	Request Extensibility Link	10000000	80H	High	Low
6	Request EPP Mode	01000000	40H	High	Low
5	Request ECP Mode with RLE	00110000	30H	High	Low
4	Request ECP Mode	00010000	10H	High	Low
3	Reserve	00001000	08H	High	Low
2	Request Device ID: Return Data Using Nibble Mode Rev Channel Transfer	00000100	04H	High	High
	Byte Mode Rev Channel Transfer	00000101	05H	High	High
	ECP Mode Transfer without RLE	00010100	14H	High	Low
	ECP Mode Transfer with RLE	00110100	34H	High	Low
1	Reserve	00000010	02H	High	Low
0	Byte Mode Reverse Channel Transfer	00000001	01H	High	High
None	Nibble Mode Reverse Channel Transfer	00000000	00H	Low	Low
	Illegal or Contradictory Request	Other than above	Other than above	--	Low

The printer only supports the Nibble and Byte modes. For a request for any other mode, Xflag is set to Low.

Data Communication from Printer to Host

Nibble Mode

In this mode, data is transferred between the printer and the host through the procedure described below. The steps beginning from (1) are applicable when the Negotiation phase has switched to the Host Busy Data Available phase. If the Negotiation phase has switched to the Host Busy Data Not Available phase, the procedure starts at step (9).

- (1) After the negotiations for the entry into Nibble mode are completed, the host sets HostBusy (nAutoFd) to Low to indicate that it is ready to receive data from the printer. (Event 7)
- (2) The printer places the low-order four bits on the reverse channel data line and sets PtrClk (nAck) to Low. (Events 8 and 9)
- (3) The host sets HostBusy (nAutoFd) to High to indicate that it has latched data and received the signal in Event 9. (Event 10)
- (4) The printer sets PtrClk (nAck) to High. This completes transfer of the first nibble. (Event 11)
- (5) Steps (1) to (3) are repeated to transfer the high-order four bits, before proceeding to steps (6) and on.
- (6) After the host has set HostBusy (nAutoFd) to High (Event 10) and received data, the printer must set the four status lines as shown below. (Event 13)
 - PtrBusy (Busy) : Returned to the status given in Forward mode.
 - nDataAvail (nFault) : Set to Low if there is data to be sent.
 - AckDataReq (PError): Set to Low if there is data to be sent.
 - Xflag (Select) : Set to the current mode (i.e., set to Low).
- (7) The printer sets PtrClk (nAck) to High. (Event 11)
- (8) After Event 11, the host checks the signals set by the printer in Event 13. With this check the host determines:
 1. Whether there is more data to be sent from the printer to the host;
 2. And whether data can be transferred from the host to the printer.
- (9) If there is no more data to be sent from the printer after the transfer of one byte (two nibbles), the host chooses one of three status selections:
 1. Performing Termination and returning to the Compatibility mode.
 2. Remaining in the Host Busy Data Not Available phase.
 3. Setting HostBusy (nAutoFd) to Low (Event 7) and moving to the Reverse Idle phase.
- (10) If there is more data to be received from the printer, the host chooses one of three status selections:
 1. Setting HostBusy (nAutoFd) to Low and indicating that the host is ready to receive.
 2. Remaining in the Host Busy Data Available phase.
 3. Performing Termination and returning to the Compatibility mode.
- (11) If the host selected the Host Busy Data Available phase and set HostBusy (nAutoFd) to Low, the printer repeats the steps from (2) onwards.

- (12) If the host selected the Reverse Idle phase and new data becomes available to be sent from the printer, the printer sets PtrClk to Low to request the host for an interrupt. (Event 18)
- (13) The printer sets PtrClk back to High. (Event 19)
- (14) Upon receiving a request for interrupt from the printer, the host responds by setting HostBusy (nAutoFd) to High. (Event 20)
- (15) Finally, the printer responds to the host by setting AckDataReq (PError) to Low, and then the host moves to the Host Busy Data Available phase. (Event 21)

Byte Mode

In this mode, data is transferred between the printer and the host through the procedure described below. The steps beginning from (1) are applicable when the Negotiation phase has switched to the Host Busy Data Available phase. If the Negotiation phase has switched to the Host Busy Data Not Available phase, the procedure starts at step (9).

- (1) After the negotiations for the entry into the Byte mode are complete, the host indicates that it is ready to receive data from the printer. This is indicated by switching the data bus to a high-impedance state and setting HostBusy (nAutoFd) to Low. (Events 14 and 7)
- (2) The printer places communication data on the data bus. (Event 15)
- (3) The printer sets PtrClk (nAck) to Low. (Event 9)
- (4) The host sets HostBusy (nAutoFd) to High to indicate that it has latched data and received the signal in Event 9. (Event 10)
- (5) The printer must set the four status lines as shown below. (Event 13)
 - PtrBusy (Busy) : Returned to the status given in the Forward mode.
 - nDataAvail (nFault) : Set to Low if there is data to be sent.
 - AckDataReq (PErr): Set to Low if there is data to be sent.
 - Xflag (Select) : Set to the status given during the last negotiation (i.e., set to Low).
- (6) The printer sets PtrClk (nAck) to High (Event 10) and ends the Byte handshake. (Event 11)
- (7) The host indicates that it has succeeded in receiving the data. This is indicated by setting HostClk (nStrobe) to Low (Event 16) and then to High. (Event 17)
- (8) Events 10 and 16 may occur simultaneously, and Events 7 and 17 may occur simultaneously. (Such as when HostBusy and HostClk are used together.)
- (9) After transferring one byte of data, the printer signals to the host whether it has more data to transfer. When there is no more data to be received by the host from the printer, the host chooses one of three status selections:
 1. Performing Termination and returning to the Compatibility mode.
 2. Remaining in the Host Busy Data Not Available phase.
 3. Setting HostBusy (nAutoFd) to Low and moving to the Reverse Idle phase. (Event 7)
- (10) When more data is to be received from the printer, the host chooses one of three status selections:
 1. Setting HostBusy (nAutoFd) to Low and indicating that the host is ready to receive.
 2. Remaining in the Host Busy Data Available phase.
 3. Performing Termination and returning to the Compatibility mode.

Device ID

The device ID is a character string that provides the ID, the type, and other information regarding the printer connected to the interface. When the printer receives a request for a device ID from the host, it replies with the following device ID:

```
<00>H<2E>H  
MFG:CBM;  
CMD:ESC/POS;  
MDL:PPU—700;  
CLS:PRINTER;
```

The first two bytes of the device ID indicate the length of the entire device ID. For a description of a request for a device ID, refer to the "Negotiation" section.

When the host receives the device ID string of the length indicated by the first two bytes, it must do so consecutively, without terminating the process until the entire device ID is received. If the process is terminated halfway, the printer discards the rest of the string; when the printer receives a new request for the device ID, it sends the device ID beginning from the first character of the ID. After receiving the ID of the length indicated by the first two bytes, the host must carry out the termination even if the printer has data to send (Data Available). If the host does not carry out Termination and tries to receive data, the printer sends the printer status.

Termination

Termination is the process of returning to Compatibility mode from the Nibble or Byte modes. When performing Termination, the host sets the signals as follows:

- IEEE 1284 Active (nSelectIn): Low
- HostBusy (nAutoFd): High (Event 22)

There are two methods of Termination:

- (1) Termination through a handshake between the host and the printer
- (2) Immediate termination

(1) Termination through a handshake between the host and the printer:

When switching from Reverse mode to Compatibility mode, this termination method can be used if the interface is activated (IEEE 1284 Active: High) and Event 22 has taken place.

- 1) The printer responds to IEEE 1284 Active by setting PtrBusy (Busy) and nDataAvail (nFault) to High. (Event 23)
- 2) The printer then inverts Xflag (Select) and sets PtrClk (nAck) to Low. (Event 24)
- 3) The host sets HostBusy (nAutoFd) to Low. (Event 25)
- 4) The printer returns nDataAvail (nFault), Xflag (Select), and AckDataReq (PError) to the status given in the Compatibility mode, and sets PtrClk (nAck) to High. (Events 26 and 27)
- 5) The host sets HostBusy (nAutoFd) to High to terminate the handshake and return the interface to the Compatibility Mode Idle phase. (Event 28)
- 6) The printer changes PtrBusy (Busy) to be able to receive data from the host.

(2) Immediate termination:

- 1) If the interface is deactivated (IEEE 1284 Active: Low) without Event 22 having taken place, the printer immediately performs Termination. In this termination, the data is not guaranteed, and the printer switches the data bus from output to input within 1 μ sec.

In the Reverse Idle phase, the printer can notify the host that it has data to transfer to the host. The notification may occur simultaneously with termination in order for the host to move from the Idle phase to the Compatibility mode.

If the printer has data to send, it initiates the Interrupt phase indicated by Events 8 and 9. In this case, if 1284 - Active (nSelectIn) was set to Low before HostBusy (nAutoFd) changed from High to Low, the printer interprets that the host has switched to the Termination phase, and then completes the normal termination through handshaking.

4.3 Identification of Send Status

Because the status sent from the printer has certain fixed bits, it is possible to identify to which command the status belongs.

When using ASB (Automatic Status Back), however, the first byte of ASB should be checked, and then the three consecutive bytes except for XOFF should be treated as ASB data.

Identification of Send Status

Command and Function	Status
GS I	<0**0****>B
GS r	<0**0****>B
XON	<00010001>B
XOFF	<00010011>B
DLE EOT	<0**1**10>B
ASB (1st byte)	<0**1**00>B
ASB (2nd - 4th bytes)	<0**0****>B

4.4 Memory Switch

Memory switch has a function to store various settings selected by the user alternatively in nonvolatile memory. Memory switch setting is retained unless the memory switch is changed.

Memory switch setting can be changed by the manual setting in memory switch change mode or by a command.

* Hereinafter memory switch is referred to as MSW.

4.4.1 Memory Switches

No.	Function	OFF	ON
MSW1-1	Power ON Info	● Valid	Not send
MSW1-2	Buffer Size	● 4Kbyte	45bytes
MSW1-3	Busy Condition	● Full/Err	Full
MSW1-4	Receive Error	● Print ?	Invalid
MSW1-5	CR Mode	● Ignored	LF
MSW1-6	Reserved	● Fixed	—
MSW1-7	DSR Signal	● Invalid	Valid
MSW1-8	INIT Signal	● Invalid	Valid
MSW2-1	Reserved	—	● Fixed
MSW2-2	Reserved	—	● Fixed
MSW2-3	Spool print	Invalid	● Valid
MSW2-4	Full col print	PPU	● EPSON
MSW2-5	Resume aft PE	● Print next line	Print top
MSW2-6	Reserved	● Fixed	—
MSW2-7	Reserved	● Fixed	—
MSW2-8	PNE sensor	● Valid	Invalid
MSW3-1	Resum Ctrr Err	● Valid	Invalid
MSW3-2	Resum Open Err	● Close	Command
MSW3-3	Parallel 31 Pin	● Valid	Invalid
MSW3-4	Paper Select	● Thermal	Black MK
MSW3-5	Reserved	● Fixed	—
MSW3-6	Reserved	● Fixed	—
MSW3-7	Emulation	● PPU-231	TM-L90
MSW3-8	Open w/Printing	● Auto	Possible
MSW4-1	Reserved	● Fixed	—
MSW4-2	Reserved	● Fixed	—
MSW4-3	Paper Top Feed	● Valid	Invalid
MSW4-4	Collect mode	● Invalid	Valid
MSW4-5	Collect Direction	● Rear	Front
MSW4-6	Collect Method	● General	Direct
MSW4-7	Print Continue	● Invalid	Valid
MSW4-8	Reserved	● Fixed	—

●: Default (Factory shipment)

4.4.2 Details of Memory Switches

Functions of memory switches, operations at ON (1) setting, and operation at OFF (0) setting are described below.

Memory switches without function setting are not explained but default must not be changed.

When setting memory switches manually, ON setting allows POWER LED to light and OFF setting allows it to go off.

(1) MSW1

- MSW 1-1: Power ON Information Send/Not send

Function: At power ON, the printer can send 3-byte Power ON Info status data (<3B>H <31>H <00>H) to the computer to inform the host that the Printer Power is turned ON.

This switch sets Send/Not send of Power ON Information.

	OFF (0)	ON (1)
Power ON Info	Send	Not send

Operation at ON (1):

Power ON Info function is disabled and no status is sent to the computer.

Operation at OFF (0):

Power ON Info function is valid and status is sent to the computer.

- MSW 1-2: Capacity of input buffer (Receive buffer)

Function: Selects the size of input buffer.

	OFF (0)	ON (1)
Buffer Size	4K bytes	45 bytes

Operation at ON (1):

Sets input buffer size to 45 bytes.

Receive buffer is full and the printer is set in the BUSY state during the period from the time the idle space decreases to 16 bytes till it increases to 26 bytes.

Operation at OFF (0):

Sets input buffer size to 4K bytes.

Receive buffer is full and the printer is in the BUSY state during the period from the time the idle space decreases to 128 bytes till it increases to 256 bytes.

- MSW 1-3: BUSY Condition

Function: Selects the condition for the printer to become BUSY state. Auto status sending function is also activated.

	OFF (0)	ON (1)
Busy Condition	Full/Err	Full

Operation at ON (1):

When receive buffer is full, the printer is in the BUSY state.

Auto status sending (ASB) function is valid.

Operation at OFF (0):

When receive buffer is full or in the offline state, the printer is in the BUSY state.

Auto status sending (ASB) function is invalid.

Supplementary explanation:

Even when ON is selected, the printer is in the BUSY state at Power ON, at the use of Reset through I/F, and at self-printing.

Printer Status		MSW1-3 OFF	MSW1-3 ON
Offline	At Power ON, at the use of Reset through I/F	●	●
	During self printing	●	●
	At cover open	●	—
	During paper feed by FEED SW	●	—
	At Paper End (Including Print Stop with PNE)	●	—
	At the occurrence of error	●	—
	At the Standby state during macro execution by FEED SW	●	—
Buffer full	At receive buffer full	●	●

- MSW 1-4: Data Processing at the occurrence of receive error

Function: Printer with serial interface detects Framing error, Overrun error, and Parity error of received data. This switch selects whether to print "?" for data with error detected.

	OFF (0)	ON (1)
Receive Error	Print?	Invalid

Operation at ON (1):

Does not print "?".

Operation at OFF (0):

Prints "?".

- MSW 1-5: CR Code Processing

Function: Selects whether the printer operates in the same manner as LF (<0A>H) when it receives the CR(<0D>H) code.

	OFF (0)	ON (1)
CR mode	Ignored	LF

Operation at ON (1):

Operates in the same manner as LF when receiving CR code.

Prints data in the print buffer and performs line feed in accordance with the amount of preset line feed.

Operation at OFF (0):

Even when the printer receives a CR code, it ignores CR code and causes no operation.

- MSW1-6: Omitted for reservation.

- MSW 1-7: Reset Valid/Invalid by DSR (Serial I/F 6 Pin)

Function: Selects whether to reset the printer by the signal of DSR (Serial interface 6 Pin).

	OFF(0)	ON(1)
DSR Signal	Invalid	Valid

Operation at ON (1):

Used as Reset signal.

Operation at OFF (0):

Not used as Reset signal.

- MSW 1-8: Valid/Invalid of Reset by the Reset signal of INIT (Serial I/F 25 pin)

Function: Selects whether to reset the printer by the INIT (Serial I/F 25 Pin) signal.

	OFF(0)	ON(1)
INIT Signal	Invalid	Valid

Operation at ON (1):

Used as a Reset signal.

Operation at OFF (0):

Not used as Reset signal.

(2) MSW2

- MSW 2-1: Omitted for reservation.
- MSW 2-2: Omitted for reservation.
- MSW 2-3: Valid/Invalid of buffered printing
Function: Selects Valid/Invalid of buffered printing.

	OFF(0)	ON(1)
Spool print	Invalid	Valid

Operation at ON (1):

Enables buffered printing.

Stores a certain amount of print buffer in the internal RAM and prints it at a time.

Prints before reaching the specified amount when a Cut command is entered.

When no Cut command is entered and the input data does not reach the specified amount, the data stored in the buffer is not printed.。

Operation at OFF (0):

Disables buffered printing.

- MSW 2-4: Full column Printing
Function: Selects the processing when print data is at the end of a line or at the right end of print width.

	OFF(0)	ON(1)
Full col print	CBM1000	EPSON

Operation at ON (1):

Performs processing compatible with that of EPSON printer.

Operation at OFF (0):

Performs processing compatible with that of CBM1000 printer.

- MSW 2-5: Processing after Cover Close and PE Clear

Function: Selects the processing to be carried out when resuming printing after the printer cover is opened or paper empty (PE) is detected during printing.

	OFF(0)	ON(1)
Resume aft PE	Next	Top

Operation at ON (1):

Resumes printing at the top of remaining data in printer.

When the printer cover is opened or PE is detected during printing of image, barcode, double-height character, or page mode and after recovery, the printer resumes printing from the top of the remaining print data.

Operation at OFF (0):

Prints from the succeeding data.

When the printer cover is opened or PE is detected during printing and after recovery, the printer resumes printing from the next position following the error.

- MSW 2-6: Omitted for reservation.
- MSW 2-7: Omitted for reservation.

- MSW 2-8: Valid/Invalid of Paper Near-End

Function: Selects Valid/Invalid of Paper Near-End.

	OFF(0)	ON(1)
PNE Sensor	Valid	Invalid

Operation at ON (1):

Disables Paper Near End.

Operation at OFF (0):

Enables Paper Near-End.

(3) MSW3

- MSW 3-1: Recovery from Cutter Lock Error

Function: Selects the method of recovery from Cutter Lock error.

	OFF(0)	ON(1)
Resum Ctrr Err	Valid	Invalid

Operation at ON (1):

Recovers by a command.

After removing the cause of the error, returns by a command <DLE+ENQ+n>.

Operation at OFF (0):

Recovers by FEED SW.

After removing the cause of the error, returns by pressing and holding (for more than 1 second) the FEED switch.

- MSW 3-2: Clearing Cover Open Error

Function: Selects the method of clearing Cover Open error.

	OFF(0)	ON(1)
Resum Open Err	Close	Command

Operation at ON (1):

When the printer detects that cover is closed and the printer receives a command <DLE+ENQ+n>, the error is cleared.

Operation at OFF (0):

When the printer detects that the cover is closed, it automatically clears the error.

- MSW 3-3: Reset signal for parallel I/F 31 Pin

Function: Selects whether to reset the printer by the signal of parallel I/F 31 Pin.

	OFF(0)	ON(1)
Parallel 31 Pin	Valid	Invalid

Operation at ON (1):

Used as Reset signal.

Operation at OFF (0):

Not used as Reset signal.

- MSW 3-4: Selecting paper

Function: Selects either thermal paper or black mark paper.

	OFF(0)	ON(1)
Paper Select	Thermal	Black MK

Operation at ON (1):
Sets black mark paper.
Operation at OFF (0):
Sets thermal paper.

- MSW 3-5: Omitted for reservation.
- MSW 3-6: Omitted for reservation.

- MSW 3-7: Selecting emulation

Function: Selects emulation.

	OFF(0)	ON(1)
Emulation	PPU231	TM-L90

Operation at ON (1):
TM-L90
Sets TM-L90-compatible emulation.
(NV image command, black mark layout command, etc.)
Operation at OFF (0):
PPU231
Sets PPU series-compatible emulation.
(NV image command, black mark layout command, etc.)

- MSW 3-8: Clearing Cover Open Error

Function: Selects the method of clearing Cover Open error.

	OFF (0)	ON (1)
Opening w/Printing	Auto	Possible

Operation at ON (1):
Printer clears error when it receives a command <DLE+ENQ+n> after detecting that the cover is closed.
Operation at OFF (0):
Printer automatically clears error when it detects that the cover is closed.

(4) MSW4

- MSW 4-1: Omitted for reservation.
- MSW 4-2: Omitted for reservation.

- MSW 4-3: Valid/Invalid of demo operation at power ON
Function: Selects Valid/Invalid of demo operation at power ON.

	OFF(0)	ON(1)
Paper Top Feed	Valid	Invalid

Operation at ON (1):

Disables demo operation at power ON.

Enters Standby mode without demo operation of paper at power ON.

Operation at OFF (0):

Enables demo operation printing at power ON.

Enables demo operation of paper at power ON.

Supplementary information:

In demo operation, paper feed of 9 lines, cutting, and paper ejection are carried out.

- MSW 4-4: Valid/Invalid of paper collecting operation
Function: Selects Valid/Invalid of collecting paper when the presenter sensor is detecting paper.

	OFF(0)	ON(1)
Collect Mode	Invalid	Valid

Operation at ON (1):

Enables paper collecting operation.

Selects whether to collect paper inside or eject paper outside the printer depending on the status of MSW4-5.

Operation at OFF (0):

Does not perform paper-collecting operation.

- MSW 4-5: Selecting Paper Collecting Direction

Function: Selects the paper collecting direction when collecting paper is set to be Valid. Valid only when MSW 4-4 is ON.

	OFF(0)	ON(1)
Collect Direction	Rear	Front

Operation at ON (1):

Ejects paper forward.

Ejects paper forward after the time set for command <GS+R+1+n> receipt collection timer has passed or by the immediate collection command <GS+R+0>.

Operation at OFF (0):

Collects paper Backward.

Collects paper inside the printer by the time for command <GS+R+1+n> receipt collection timer has passed or by the immediate collection command <GS+R+0>.

- MSW 4-6: Selecting Paper Ejection Start Timing from Presenter

Function: Selects the timing for starting paper ejection from the presenter. When MSW4-4 is ON and MSW4-5 is OFF, the printer performs direct eject operation regardless of the status of MSW4-6.

	OFF(0)	ON(1)
Collect Method	General	Direct

Operation at ON (1):

Ejects directly.

When paper reaches the top of the presenter, the printer starts ejecting paper in synchronization with the line feeding without loosening of paper.

Operation at OFF (0):

Ejects normally.

Printer does not eject paper even when paper reaches the top of the presenter but it ejects paper after loosening paper by 300 mm max. When paper length reaches 300 mm, direct ejection is used.

- MSW 4-7: Valid/Invalid of Continuous Operation of Paper Ejection

Function: Selects Valid/Invalid of paper eject operation of next paper while presenter sensor is detecting paper.

	OFF(0)	ON(1)
Print Continue	Invalid	Valid

Operation at ON (1):

Enables Continuous operation.

Enables the paper eject operation of next paper even if the presenter sensor is detecting paper.

Operation at OFF (0):

Disables Continuous operation.

Disables the next eject operation when the presenter sensor is detecting paper. Printer ejects next paper after the sensor has become the state of not detecting paper.

- MSW 4-8: Omitted for reservation.

4.5 Black Mark Layout and Operating Condition

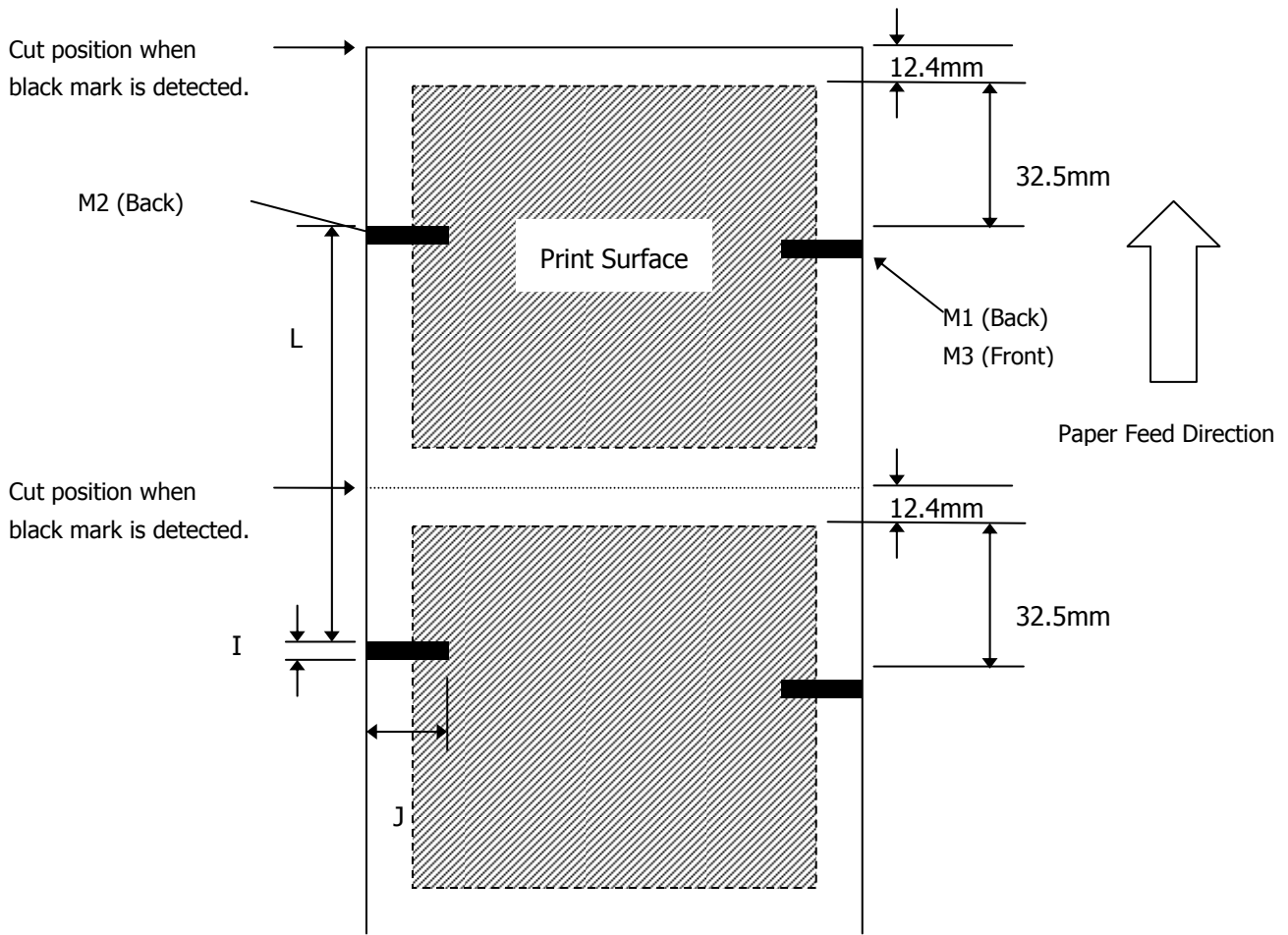

Symbol	Item	BM Paper
I	Black mark length	5~10mm
J	Black mark width	10mm 以上
L	Black mark pitch	100mm~3000mm

- Black marks are selected at two places on the back and one place on the front (PCS value is 0.9 or more).
- * BM position is an option of factory shipment.
- Though printing is available on the printing side having a black mark on the back, print density may become thin depending on the type of paper; therefore, user's notice such as printing on the place without black mark is necessary.
- Distance between black mark and black mark sensor is approx. 32.5 mm. If black mark is detected within this distance, next black mark is detected.
- Cut position when black mark is detected by the GS+S command (black mark detection command) is about 45 mm with the top of black mark used as a reference.
- Amount of automatic paper feed at the detection of black mark can be set by the ESC Y n1 n2 command.
- Basically cut command can be executed in any condition. If minimum distance for issuing a ticket (80 mm) is not satisfied, paper feed as much as the shorted amount is added by the printer.
- * The user is requested to prepare the printing layout in consideration of the above regulations.