

# Bill Validator

U70. U77. U85

## Installation Guide

*Series*

- Ultimate acceptance rates .
- Superior security.
- Fast , efficient bill handling .
- Combines the bill handling and the advanced bill recognition system to increase acceptance rates and reduce jams .
- Easy to remove/open /clean acceptor .
- Auto self - adjusting sensor system
- Quick to update software (flash ROM).
- 99.99% efficiency on Anti-String (fishing) feature.

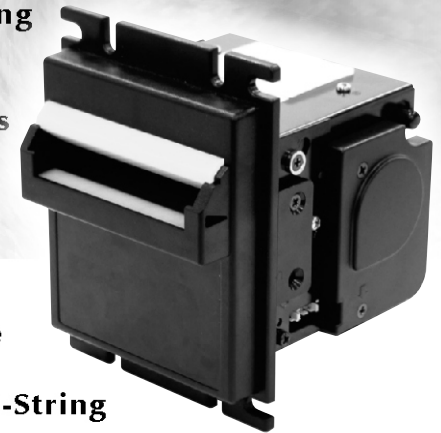

## **U70. U77. U85 Bill Validator Specifications**



### **Acceptance Rate**

96% or greater

### **Bill Insertion**

4 - way Acceptance

### **Acceptance Speed**

Approx. 4 seconds

### **Interfaces**

Pulse

### **Weight**

Approx. 1kg

### **Power**

DC +12V

### **Power Consumption**

Standby 125mA

Operating 860mA~1.5A

### **Environment Range**

Operating temperature 0°C~55°C

Storage temperature -20°C~60°C

Humidity 30%~85% RH  
(no condensation)

## **U70. U77. U85 Bill Validator Dimensions**

U70 / U70-P6 (see page 2).

U77 / U77-P2 / U77-P6 1-WIDTH ENTRANCE (see page 3).

U77 / U77-P2 / U77-P6 2-WIDTH ENTRANCE (see page 4).

U77H2 (see page 5).

U85 (see page 5).

U77-Rounded / Lock-on (see page 6).



## U70/P6

Bill width available 60mm~70mm.

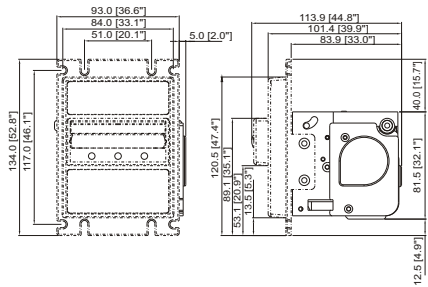

Unit: mm[inch]

● BILL VALIDATOR

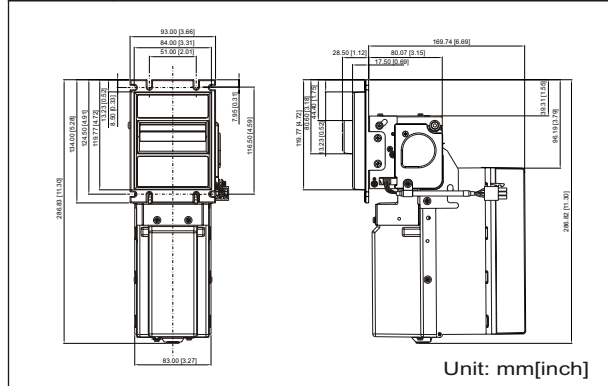

Unit: mm[inch]

● P6 PLASTIC STACKER(600pieces)

## U77/P6/P2

1 - WIDTH ENTRANCE  
Bill width available 60mm~77mm.

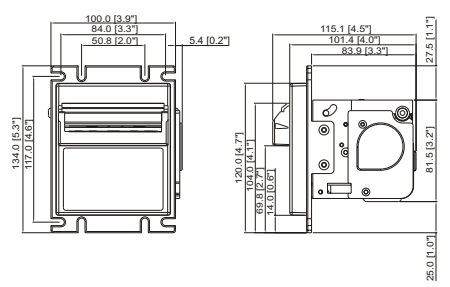

Unit: mm[inch]

● BILL VALIDATOR

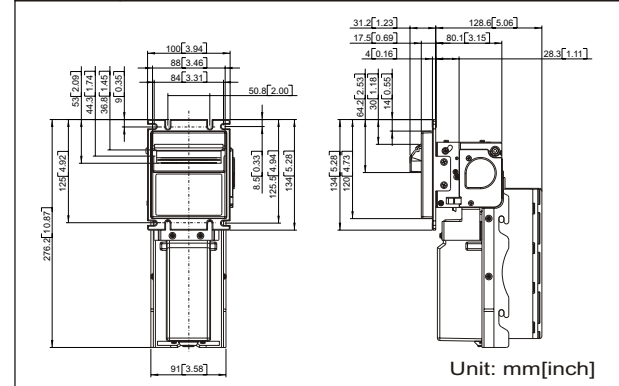

Unit: mm[inch]

● P2 PLASTIC STACKER(200pieces)

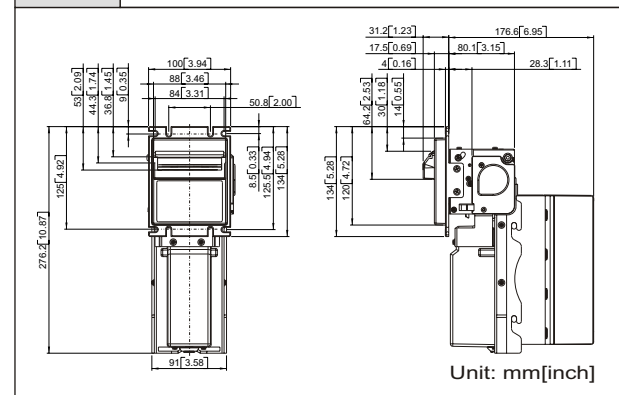

Unit: mm[inch]

● P6 PLASTIC STACKER(600pieces)





## U77

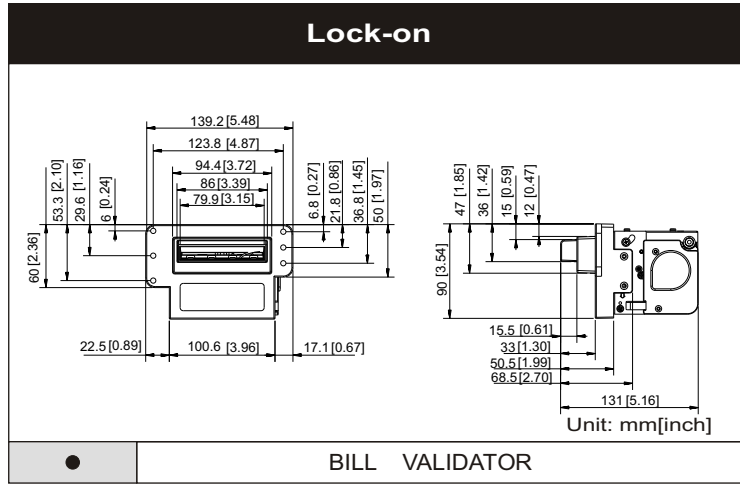
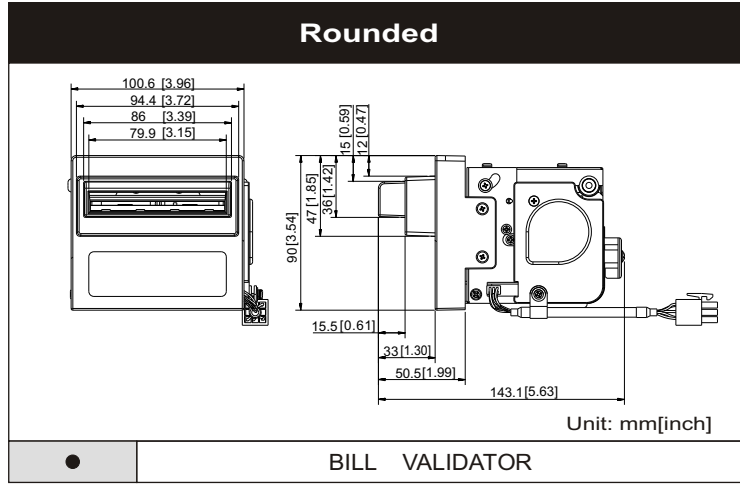

## Interface Harness

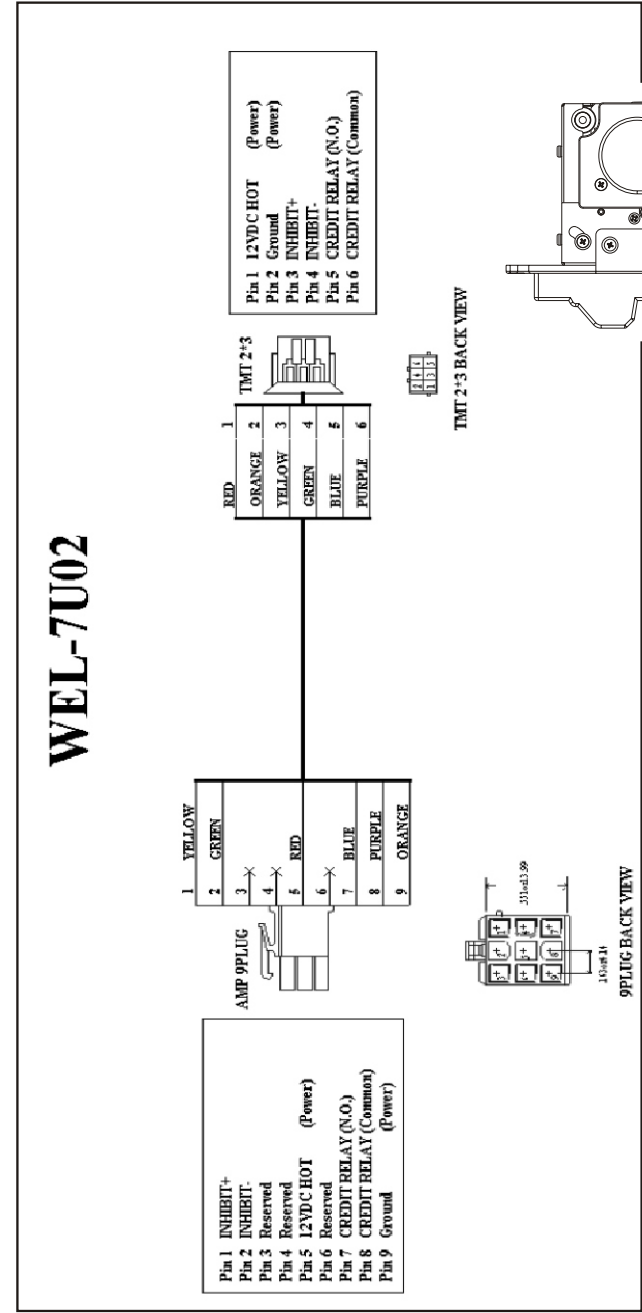

## Download Harness

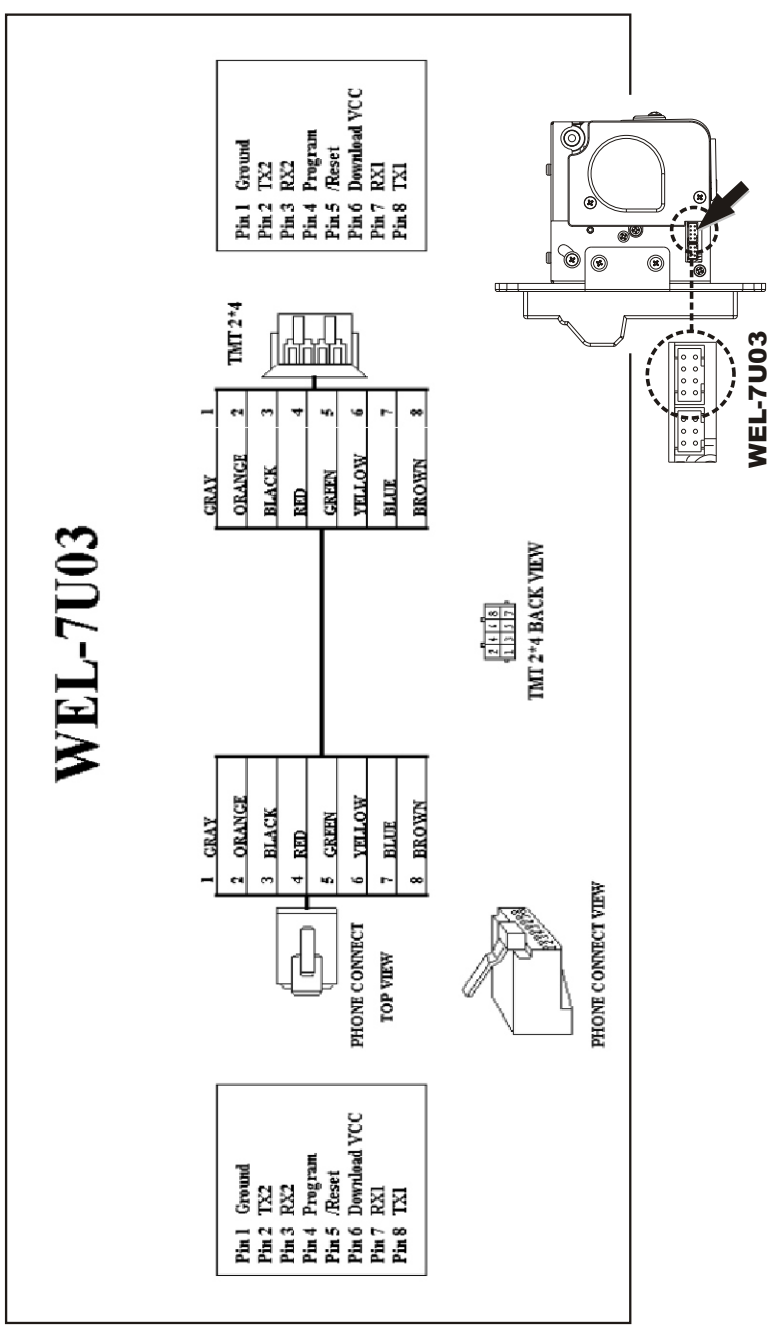

## Interface Harness

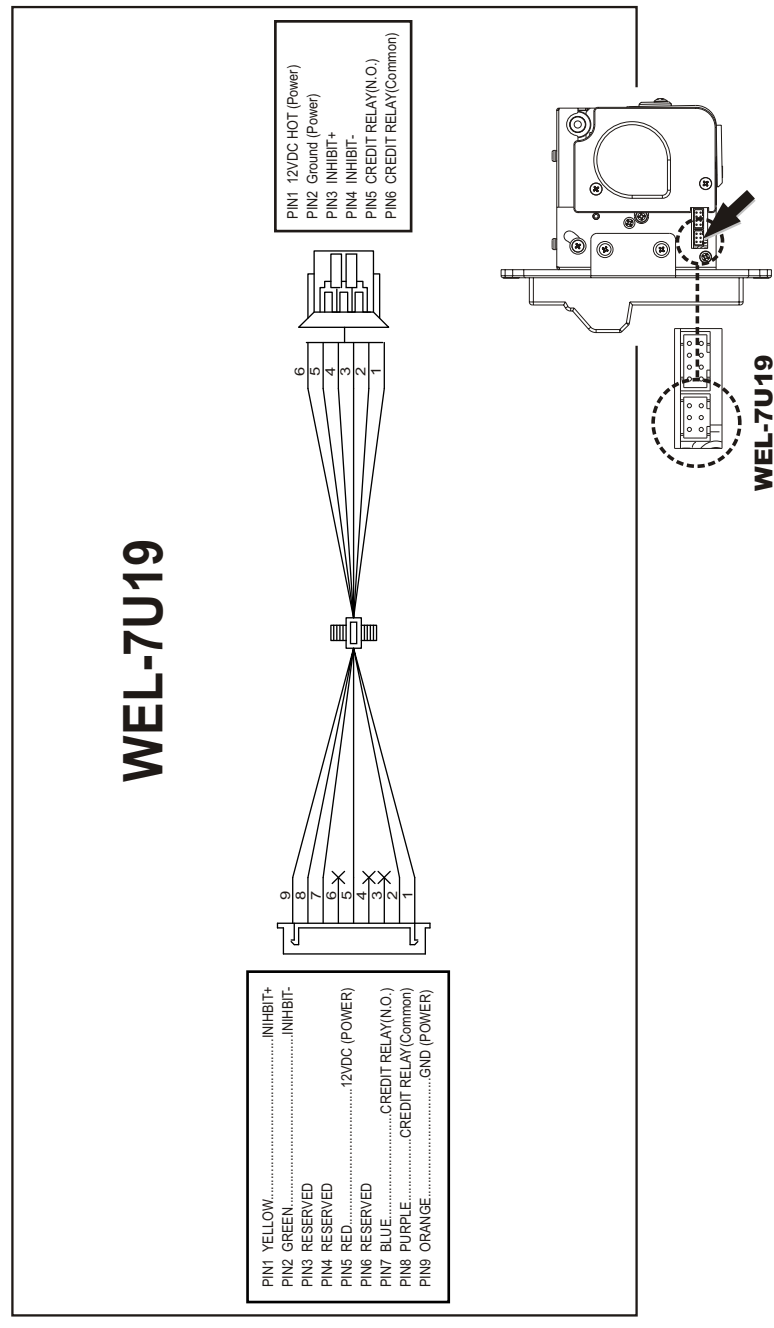

## Software update: through "FP-001" download box

Step 1 : Get software from "ICT" .



Step 2 : Download the software into "FP-001" by "PC" .

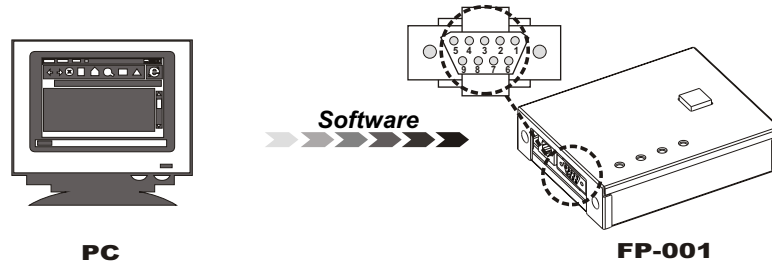

1. Please follow the downloading procedures described in FP-001's manual.

Step 3 : Download the software into "BA" by "FP-001" .

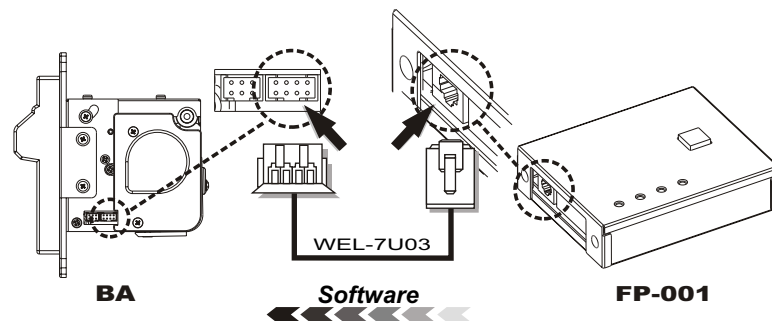

1. Please follow the downloading procedures described in FP-001's manual.  
2. B.A. must be powered on when it is connected to FP-001.

## U70. U77. U85 LED Status

	FLASHES	STATUS
RED	1	Bill jammed
	2	Inhibit
	3	General sensor problem
	3+1	Special sensor problem
	3+2	Hook sensor problem
	3+4	Fish sensor problem
	4	Bill fish
	7	Motor problem
	LED ON	POWER ON
	LED OFF	POWER OFF

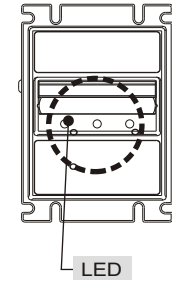



## **U70. U77. U85 Cleaning**

Residuals on LEDs and sensors can cause bill jams and decrease acceptance rates.

According to the environment around the bill acceptor clean internal part from every two weeks to every two months.

1. Turn off the power
2. Open LED Assembly.
3. Use a soft cloth or cotton swab to clean internal parts and bill path.

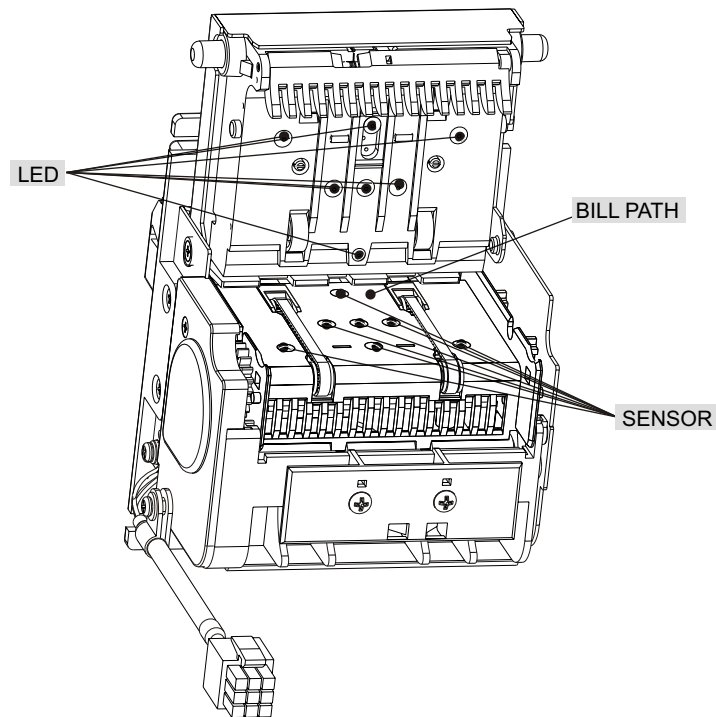

Never use an organic solvent such as gasoline or paint thinner to clean the unit.